



**Zimmer®
Trabecular Metal™
Humeral Stem
Four-Part Fracture**

Surgical Technique



Evolution Meets Revolution

Trabecular Metal™ Humeral Stem Four-Part Fracture Surgical Technique

Developed in conjunction with

Louis Bigliani, M.D.
New York Presbyterian Hospital
Columbia-Presbyterian Center
New York, New York

Evan Flatow, M.D.
Mount Sinai Medical Center
New York, New York

Ian Kelly, M.D.
Glasgow Royal Infirmary
Glasgow, Scotland

George M. McCluskey III, M.D.
McCluskey Orthopaedic Surgery
Columbus, Georgia

Anthony Miniaci, M.D.
The Cleveland Clinic Foundation
Cleveland, Ohio

Gregory P. Nicholson, M.D.
Rush University Medical Center
Chicago, Illinois

Michael L. Pearl, M.D.
University of Southern California
Los Angeles, California

Ken Yamaguchi, M.D.
Washington University
St. Louis, Missouri

Table of Contents

Introduction	2
Patient Positioning	2
Incision and Exposure	3
Humeral Preparation	4
Ream Humeral Canal	4
Provisional Selection	5
Sizing Convention and Considerations	5
Stem Provisional Selection	5
Humeral Head Provisional Selection	6
Prepare and Insert Stem Provisional	7
Implant Final Components	10
Reattach Tuberosities	12
Humeral Head Removal	14
Closure	14
Postoperative Management	14
Case Layouts	15

Introduction

A hemiarthroplasty is indicated when salvage of the native humeral head is either not possible or impractical. This is the case in most head-splitting fractures of the humeral head, and in impression fractures involving more than 40 percent of the head.

In a typical or “classic” four-part fracture (Fig. 1), the humeral head fragment is separate from the shaft and both tuberosities, and is dislocated out of the glenoid. The greater and lesser tuberosities are separated from the head fragment, but may be connected to or separate from each other. The head is devoid of all soft-tissue attachment, creating a high probability of avascular necrosis. For this reason, a hemiarthroplasty is typically used in older patients. In younger patients, especially those with a “valgus impacted” pattern, internal fixation may be employed.

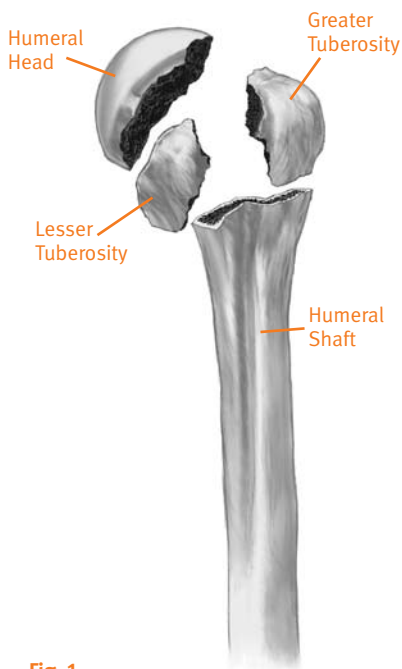

Fig. 1

In a three-part fracture (Fig. 2), the head and one of the tuberosities (usually the lesser tuberosity) are together, and both are separated from the shaft and the other tuberosity. Most three-part fractures are best treated by internal fixation. However, in some elderly patients with very osteoporotic bone, it may be difficult to achieve adequate fixation to allow early motion. In these cases, a hemiarthroplasty may be a good salvage procedure.

The goal of hemiarthroplasty for fracture is to replace the humeral head with a prosthetic component, reconstruct the rotator cuff, and reconstruct the tuberosities to both the shaft and the prosthesis.

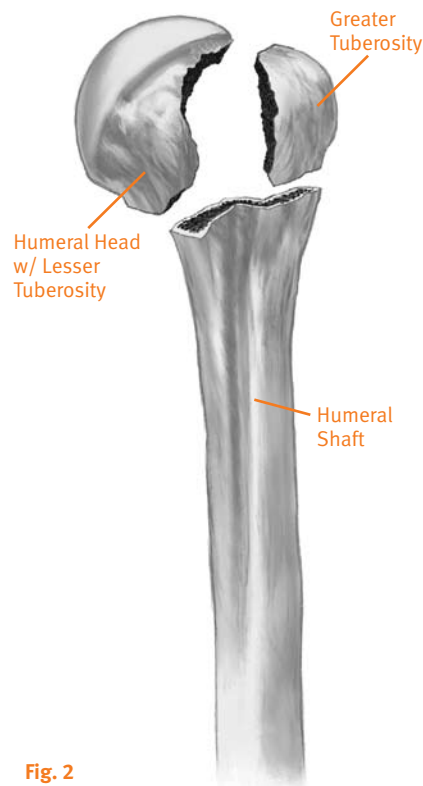

Fig. 2

Patient Positioning

Patient positioning is especially important in shoulder surgery. Place the patient in a semi-beach-chair position with the knees flexed (Fig. 3). Raise the head of the table approximately 25°-30° to reduce venous pressure. Use a head rest that allows for the superior part of the table to be removed. Place two towels under the spine and the medial border of the scapula to raise the affected side. Bring the shoulder up and out. Attach a short arm board to the table, or use another arm support method that will allow the arm to be raised or lowered as necessary throughout the procedure.



Fig. 3

Incision and Exposure

Mark the clavicle, the acromion, and the coracoid process for reference. Then mark the line of the incision, beginning at the clavicle just lateral to the coracoid process. Extend the line along the deltopectoral groove to the area of the deltoid insertion at the mid-humerus (Fig. 4).

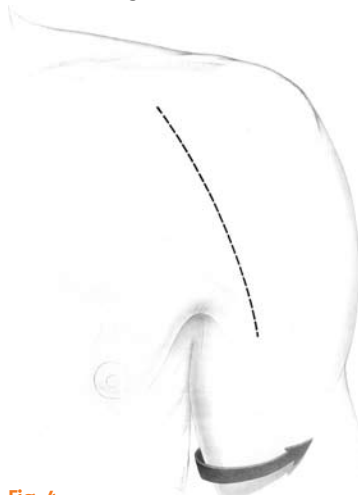

Fig. 4

Make the long deltopectoral skin incision following the line. Undermine the skin flaps to improve exposure. Then dissect subcutaneous tissue from the deltoid fascia, and expose the deltoid and pectoralis major muscles. Retract the skin by placing Gelpi retractors about one-third of the way down, and one-third of the way up. Develop the deltopectoral interval, retracting the pectoralis major medially and the deltoid laterally. Tie off the crossing vessels. Identify and dissect the interval between the pectoralis major muscle and the cephalic vein. Protect the cephalic vein by retracting it either medially or laterally. Retracting the vein medially will make it easier to avoid the vein when reaming. Retracting the vein laterally will help minimize bleeding from the deltoid

muscle, requiring less tying off of feeder vessels and often resulting in less swelling. Release the upper 1cm-2cm of the insertion of the pectoralis major tendon, being careful to avoid the long head of the biceps tendon. In very tight shoulders, the pectoralis may need to be completely released. Tag the pectoralis major muscle with a suture so it can be easily identified for later reattachment. Reposition the distal medial retractor under the pectoralis major muscle.

Release any adhesions between the deltoid and strap muscles (coracobrachialis and short head of biceps) and develop a plane between the strap muscles and the humerus. Reposition the proximal medial retractor under the strap muscles (Fig. 5).



Fig. 5

In approaching the fracture, both the humeral shaft and the humeral head fragments may be in a medial position which may distort the surgeon's orientation. Be careful to avoid spreading the muscular interval too far and penetrating the strap muscles. If the head is dislocated in the axilla inferior to the subscapularis muscle and capsule, palpate the coracoid to determine the correct interval. Cautious dissection is required to avoid injury to the neurovascular structures. This may require further release of the pectoralis major tendon. Careful palpation of the fragments to identify sharp edges is required to avoid neurovascular injury during removal. These patients must have careful preoperative examination.

Identify the greater and lesser tuberosities. The lesser tuberosity will be medial to the biceps tendon, and the greater tuberosity will be lateral and posterior. Tuberosity fragments can be mobilized from the shaft on either side of the bicipital groove. Remove the hemorrhagic bursa to improve the exposure.

If necessary, further release the tuberosities by dissecting soft tissue from their perimeters. If the tuberosities are still connected, reattach them together. If there is a crack between the tuberosities, separate them for reattachment. If the tuberosities are already separate, divide them at the point where they are already split, which is usually just lateral to the bicipital groove. Place sutures around the lesser tuberosity, and isolate it with the subscapularis attachment.

Assess the biceps tendon. If it is badly torn and frayed from contact with the sharp bone fragments, consider releasing the tendon or tendons. Some surgeons believe it can be a source of pain, and may stick down in a fracture and cause stiffness. However, if the biceps groove is not involved in the fracture, the tendon can be spared.

Palpate and identify the axillary nerve beneath the subscapularis muscle to be sure that it is free and clear. Then remove capsular tissue as necessary to avoid sticking and scarring. It may be necessary to partially release the subscapularis muscle from the capsule.

In the same manner, partially release the greater tuberosity and rotator cuff from the capsular tissue. If any fragments of articular surface are still attached to the greater tuberosity, remove them with a rongeur.

Place two #5 braided nylon sutures around each fragment. The sutures will be used to manipulate the fragments during the procedure and may be used to reduce the fracture at the end of the procedure. Tie off the circumflex vessels. Remove the fractured articular head segment, preserving it for head selection and for bone graft later in the procedure. Then expose the humeral shaft and assess its condition.

With the tuberosities retracted, suction the humeral canal.

In most fractures, the humeral head will break off cleanly from the medial calcar. This leaves a sufficient amount of calcar to determine the appropriate height of the implants. If this is the case, assess the proper height and retroversion of the prosthetic components by holding the humeral head fragment in its normal position on the humeral shaft. If desired use a

ruler to measure the distance between the top of the humeral head and the superior edge of the fractured shaft (Fig. 6). This distance can be used as a reference for determining the height of the Humeral Stem Provisional, or the humeral implant later in the procedure.



Fig. 6

Humeral Preparation

The goal of humeral preparation is to place a prosthetic articular surface precisely on the proximal humerus in the same position as it was before the fracture. The relationship among bony anatomy, rotator cuff insertions, and soft tissue tension must all be considered.

Ream Humeral Canal

Attach the Ratchet T-handle to the appropriate size blunt-tipped Intramedullary Tapered Reamer (Fig. 7). There are three positions marked on the collar of the T-handle—FORWARD, LOCKED, and REVERSE. Set the instrument to the FORWARD position (Fig. 8).

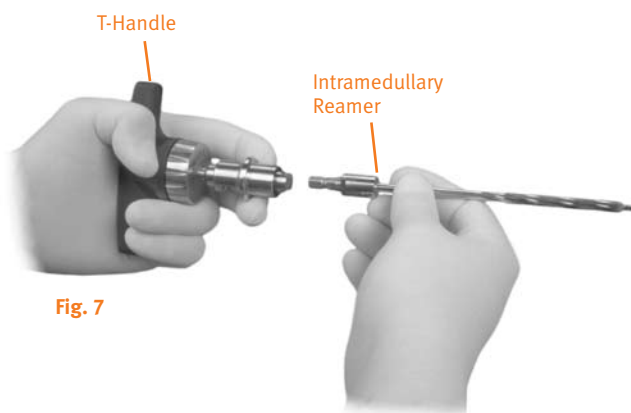

Fig. 7



Fig. 8

Manually ream the humeral canal using progressively larger reamers in 1mm increments until slight resistance is felt from cortical contact in the canal. Ream to the appropriate depth for the selected stem length (Fig. 9). The depth corresponds to the implant length to be used. For a 130mm stem, ream until the first mark on the reamer is at the approximate level of the surgical neck. For a 170mm stem, ream until the second mark on the reamer is at the approximate level of the surgical neck.

Note: Do not remove cortical bone.

The reamers have blunt tips to help guide them down the canal and prevent obturation into cortical bone.



Fig. 9

Remove the Ratchet T-handle and the Intramedullary Tapered Reamer.

Provisional Selection

The *Trabecular Metal* Humeral Stem was designed for a number of indications, including primary, fracture and revision arthroplasty. The sizing nomenclature is based on the actual size of the components. In press fit applications the size of proximal and distal reamers used to prepare the canal determines the definitive implant size. In cemented applications, the surgeon will determine the amount of cement mantle they desire and prepare the canal accordingly.

Sizing Convention and Considerations

Proximal geometry is the same for consecutive odd to even distal stem sizes. For example, the 9mm and 10mm stems have the same tapered proximal geometry with a 1mm difference in stem size distally. This feature is important when considering stem size and cement usage.

If the canal is initially reamed to an EVEN distal diameter size (e.g. 10mm), the odd size distal stem (e.g. 9mm) can be inserted leaving approximately a 1/2mm circumferential cement mantle thickness around the distal stem. The tapered proximal geometry will then gradually eliminate the cement mantle in the proximal shaft. In effect this can “seal” the canal from proximal cement extrusion. If a larger cement mantle is desired, then the surgeon may consider reaming the distal canal to a greater diameter, (e.g. 11mm) while maintaining the same stem size (e.g. 9mm). Alternatively, to achieve a larger cement mantle the next smaller size of implant may be chosen (e.g. 8mm) however in this situation the cement mantle will extend up into the proximal geometry as the proximal geometry will be smaller (8mm stem relative to 10mm reamed preparation). Also note that if the larger size of proximal provisional is used the tuberosities may not sit in the same place relative to reconstruction on the implant.

If the canal is initially reamed to an ODD stem size (e.g. 9mm), then the surgeon can choose to go back and ream the distal canal 1mm larger (e.g. 10mm) and insert the odd size stem and maintain the proximal “sealing” of the canal. Alternatively, a smaller size stem can be chosen but the sealing effect will be lessened due to the smaller proximal geometry.

Stem Provisional Selection

Select the Proximal Provisional that is the same size as the last Intramedullary Reamer used. Select the Distal Pilot that is two millimeters smaller than the diameter of the reamed canal to use the Foam Sleeve. The Foam sleeve helps hold the provisional construct in place. Attach the Distal Pilot to the *Trabecular Metal* Humeral Stem Provisional (Fig. 10). **Note: the 6mm provisional is a “monoblock” style.**

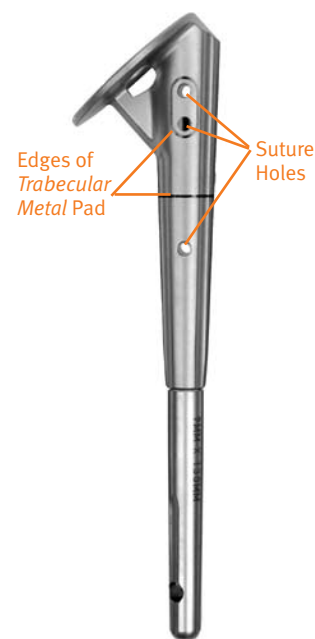
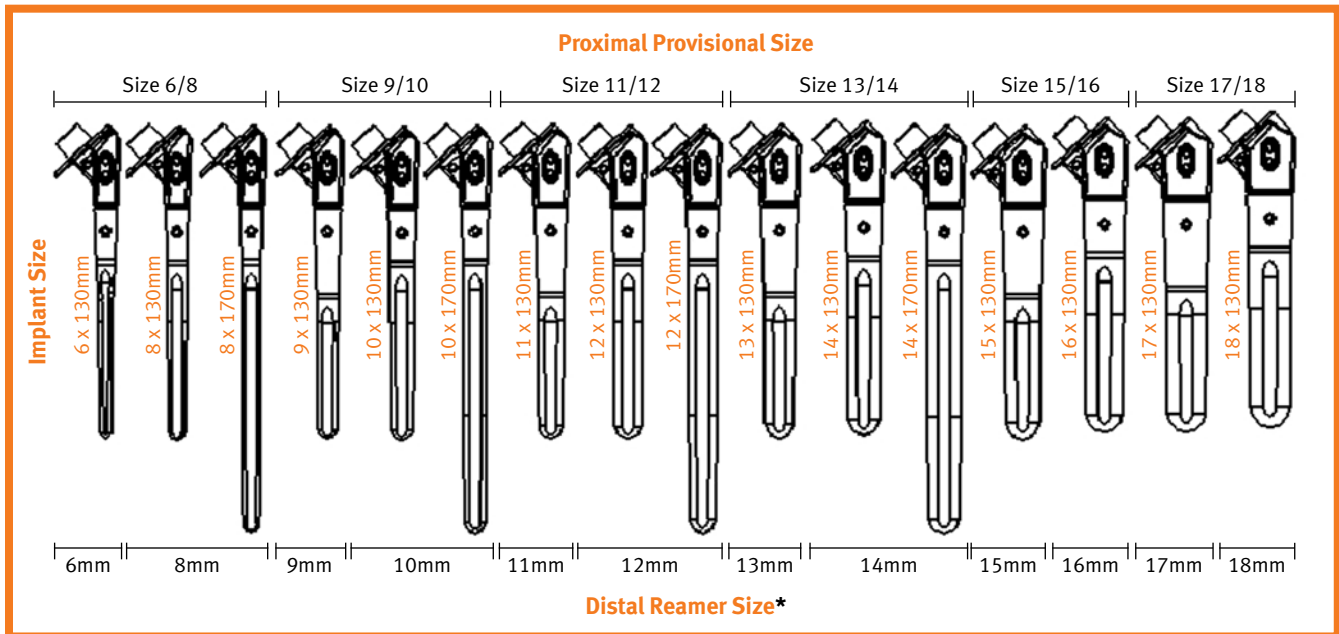

Fig. 10

Humeral Reaming



***Note:** As described previously, if cementing distally, a larger distal reamer or a smaller stem may be used to create a cement mantle.

Note: 6mm Reamer does not use a Distal Pilot.

Foam sleeves have tethers attached and are available in four sizes: small, medium, large, and extra-large. Use the selected Humeral Stem Provisional size to determine the sleeve size according to the following table.

Stem Provisional Size	Sleeve Size
6mm-8mm	Small
9mm-11mm	Medium
12mm-14mm	Large
>15mm	X-Large

Slide the appropriate size Foam Sleeve onto the selected Humeral Stem Provisional (Fig. 14).

The sleeves are designed to fit snugly on the distal portion of the Humeral Stem Provisional to help assess axial height and provide additional stabilization in the canal. They are not packaged with the stems; a separate sterile package contains one of each size sleeve.

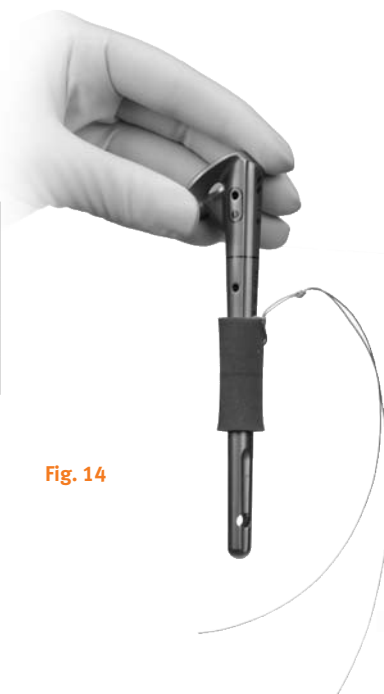

Fig. 14

Humeral Head Provisional Selection

Standard and offset humeral heads are available. An eccentrically positioned humeral head will place asymmetric tension on the rotator cuff. If the anatomy places the collar of the Humeral Stem Provisional eccentrically, consider using an offset head. Offset is adjusted by rotating the Humeral Head Provisional until it is positioned anatomically on the medial calcar. Ideal placement of the humeral head will be achieved when the head is centered relative to the rotator cuff.



Fig. 11

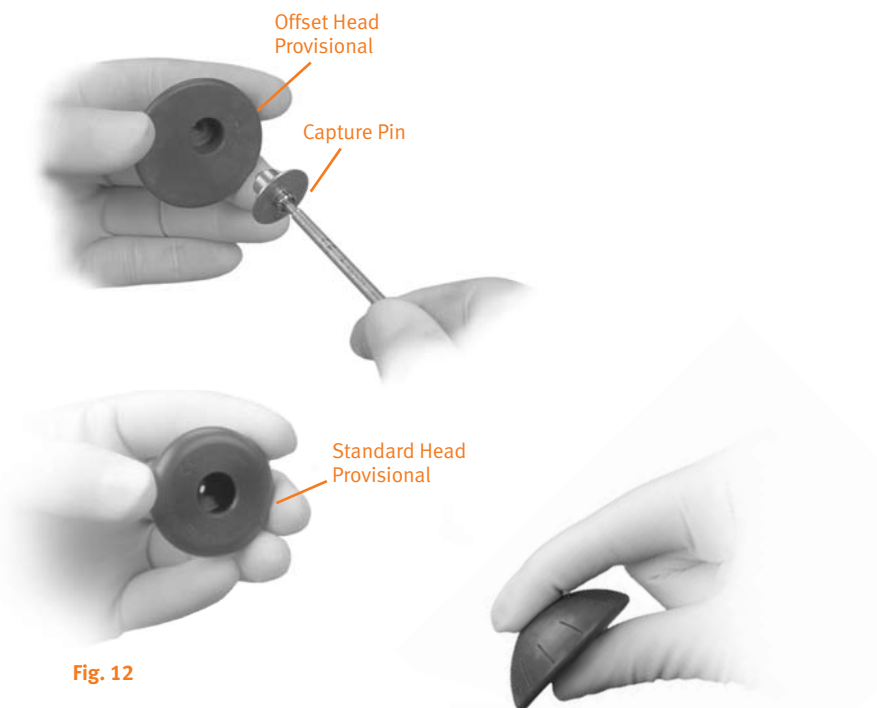

Fig. 12

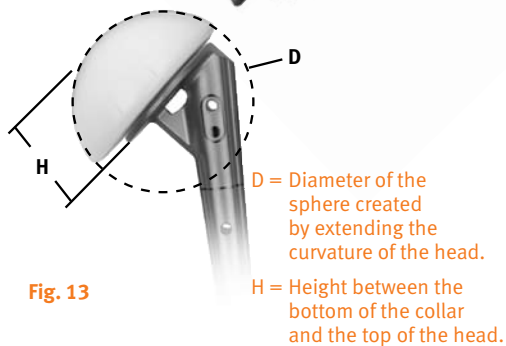

Fig. 13

Choose the size of the humeral head component by comparing the Humeral Head Provisional with the humeral head fragment (Fig. 11). Select a prosthetic head that approximates the size and curvature of the one removed. Insert a metallic capture pin to the humeral head provisional (Fig 12). Select the humeral stem provisional that matches the last intramedullary reamer used. Then attach the selected Humeral Head Provisional to the Humeral Stem Provisional and again compare it side by side to the humeral head fragment (Fig 13). Remove the Humeral Head Provisional.

Prepare and Insert Stem Provisional

The Fracture Instrument is available in three sizes (15mm, 18mm, 21mm) and in both right and left configurations. This instrument is used to set the height and retroversion of the provisionals and implants. It is also used to reference the height of the humeral component relative to the superior aspect of the shaft fragment. A handle on the Fracture

Instrument facilitates positioning of the Humeral Stem Provisional and the humeral stem implant. Additionally, the handle accepts the Ruler, which can alternatively be used to reference the height of the humeral component.

Attach the appropriate right or left 15mm Fracture Instrument to the Humeral Stem Provisional by inserting the peg of the Fracture Instrument into the superior hole on the provisional shaft (Fig. 15). Then use the Pin Wrench to turn the hex screw clockwise until the blade of the Fracture Instrument firmly contacts the underside of the collar on the Humeral Stem Provisional (Fig. 16). This will secure the Fracture Instrument to the Humeral Stem Provisional.



Fig. 15



Fig. 16

Attach the appropriate size Humeral Head Provisional, and insert the assembly into the humeral canal. The most distal point on the 15mm Fracture Instrument is 15mm below the zero point of the stem as referenced on the templates (Fig. 17). Therefore, the height of the provisional, at the zero point, will be 15mm above where the instrument contacts the fracture surface.

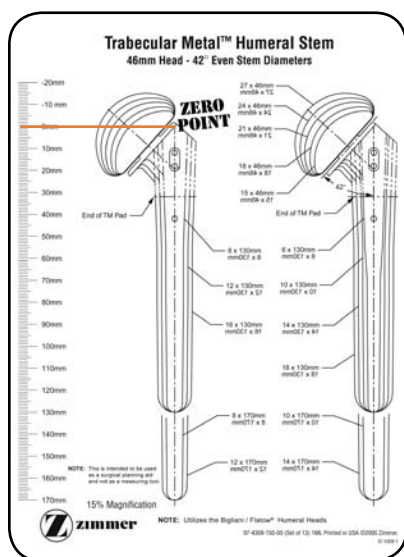

Fig. 17

Insert Threaded Alignment Rods into the appropriate 20° and 40° holes on the Fracture Instrument (Fig. 18). Use the forearm as a reference to adjust the version of the provisional stem. The forearm should be between the alignment rods, but closer to the 20° rod (Fig. 19). Humeral stems are typically placed more toward 20° of retroversion to aid fracture and subscapularis healing.



Fig. 18



Fig. 19

Assess the height of the provisional construct using the bottom edge of the Fracture Instrument as a reference relative to the shaft (Fig. 20).



Fig. 20

Determine the appropriate height by reducing the tuberosity fragments relative to the diaphysis and adjusting the height of the provisional construct so the tuberosities are just tucked in under the collar (Fig. 21). Establishing height is facilitated if there is a large spike on the greater tuberosity that keys in on a defect. The humeral head is typically placed 2mm-3mm above the keyed-in greater tuberosity.



Fig. 21

If the tuberosity fragments overlap the shaft, raise the Humeral Stem Provisional 3mm or 6mm by using the 18mm or 21mm Fracture Instrument, respectively. Again, use the bottom edge of the instrument as a reference relative to the shaft.

Optional Height Adjustment Technique

Attach the *Bigliani/Flatow*® Fracture Ruler to the Fracture Instrument by sliding the Ruler over the arm of the instrument. Use the Pin Wrench to tighten the screw (Fig. 22). When the version and height of the Humeral Stem Provisional are set, mark the position by using a pin driver to insert a 3.2mm threaded pin through the central slot of the Ruler. Note the position of the pin as indicated on the Ruler (Fig. 23). The implant will later be positioned by placing the Ruler over the pin down to the same level that was noted with the provisional.



Fig. 22

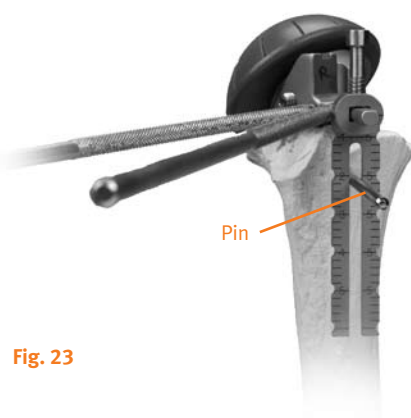

Fig. 23

If, when the 15mm Fracture Instrument is resting on the superior aspect of the shaft fragment, there is a gap between the greater tuberosity and shaft fragments, remove the Fracture Instrument and lower the stem until the tuberosity fragment sits flush with the shaft fragment. Use the laser marks or holes on the provisional to note the height relative to the shaft and mark the bone at the edge of the laser mark for version reference (Fig. 24). **Note: these references will be used to guide the placement of the final implants thus reproducing this position.**



Fig. 24

Reduce the joint and assess range of motion. Place the tuberosity fragments in their approximate anatomical position below the collar of the Humeral Stem Provisional to help confirm proper positioning of the provisional components.

Once a satisfactory position is attained, remove alignment rods and note the version/position of the Fracture Instrument. To create a reference for the appropriate retroversion when positioning the final humeral stem implant, mark the bone relative to a selected point on the Fracture Instrument (Fig. 25). If the Ruler assembly is used, note the new position of the pin relative to the height marking on the Ruler.



Fig. 25

As a point of reference, note which etch mark on the clock face of the Offset Humeral Head Provisional lines up with the medial fin on the Humeral Stem Provisional.

Remove the provisional components and discard the Foam Sleeve. **Note: Do not use the Foam Sleeve tether to remove the Humeral Stem Provisional.** Use the Pin Wrench to loosen the screw on the Fracture Instrument and remove it.

Clean the fracture site at the shaft edges and place drill holes through the shaft; two lateral to the biceps groove and two medial to the biceps groove. Place #5 nylon sutures through the shaft drill holes. These will be greater tuberosity and lesser tuberosity vertical sutures that will go up around the top of the bone segments through the rotator cuff-bone junction.

Note: The number and location of sutures may be altered depending on fracture pattern.

Implant Final Components

Humeral stem implant size is selected based upon technique and fixation desired. For example, if cementing and a cement mantle is desired, choose the implant size that is smaller than the last intramedullary reamer used. If a press fit is desired, choose the size that is equivalent to the last intramedullary reamer used. Refer to *Sizing Convention and Considerations* section for additional information. Humeral Head Implant size is the same size as the provisional chosen previously.

Attach the humeral head implant to the taper of the humeral stem implant. Ensure that the humeral stem taper is clean before assembly. If using an offset humeral head, there are two ways to attach the humeral head component.

- 1 Hold the humeral head component so that the clock face on the inferior side is visible. The etch marks on the component correspond to those on the Humeral Head Provisional. Place the taper of the humeral stem component into the hole so that the medial fin is at the previously determined reference point on the clock face (Fig. 26). Then impact it in place.



Fig. 26

- 2 Attach the offset humeral head component to the Offset Humeral Head Inserter so that the single prong is positioned at the previously determined reference point on the clock face (Fig. 27). Then place the head onto the stem so the single prong of the inserter is in line with the medial fin of the humeral stem component. Remove the Offset Humeral Head Inserter. Then impact it in place.



Fig. 27

Note: Do not use the Foam Sleeve with the final humeral stem implant.

Attach the appropriate Fracture Instrument onto the humeral stem by inserting the peg of the Fracture Instrument into the superior hole of the implant. Then use the Pin Wrench to turn the hex screw clockwise until the blade of the Fracture Instrument firmly contacts the underside of the collar on the stem. This will secure the Fracture Instrument to the stem (Fig. 28). If using the Ruler, slide it onto the arm of the Fracture Instrument and use the Pin Wrench to secure it (Fig. 29).



Fig. 28



Fig. 29

Note: If use of the most distal stem suture hole is deemed necessary due to insufficient bone stock, sutures are placed in the most distal suture hole prior to final stem insertion.

Before injecting cement into the canal, insert the final assembled components, and check their final position and fit. Remove the components, and thoroughly clean and dry the humeral canal.

Inject cement into the canal. Use a finger to thoroughly pack the cement.

Using the arm of the Fracture Instrument as a handle, insert the assembled components into the canal until the fracture instrument contacts the fracture surface or insert the stem to the predetermined height above the diaphyseal fracture line (Fig.30). Position the stem in the desired retroversion by aligning the reference point on the Fracture Instrument with the mark made earlier on the bone.



Fig. 30

If using the Ruler, insert the humeral stem to the same level on the Ruler relative to the pin that was inserted earlier when the provisional components were used (Fig. 31).



Fig. 31

If the fracture instrument is not used, insert the stem until the collar contacts the remaining calcar or until you have reached the predetermined height above the fracture line using other landmarks.

Note: Be careful to avoid contact between the cement and the Trabecular Metal material above the shaft fracture line as the cement will interfere with the biological ingrowth properties of the material.

Insert Threaded Alignment Rods into the 20° and 40° holes on the Fracture Instrument. Then confirm axial height and retroversion before the cement is fully cured (Fig.32).



Fig. 32

Remove the Fracture Instrument from the implant. Use the Pin Driver to remove the 3.2mm threaded pin if the ruler was used.

Make certain that there is no excess cement extruding from the canal proximally above the humeral stem into the fracture site. This will interfere with the potential for bony union between the tuberosities, stem, and the diaphyseal fragment. Use a curette to remove any excess cement. It is important to keep the heavy nylon sutures separated to avoid confusion in tying the proper sutures.

Note: Avoid cementing the Fracture Instrument in place by removing any bone cement in contact with the instrument before curing if instrument has been left in place.

After reducing the joint, perform a final range of motion assessment.

Reattach Tuberosities

Fixation of the tuberosities is critical to the success of the procedure. Basic principles in fracture repair should be followed to provide stable fixation of the tuberosities into the stem. The following description provides guidelines for using of the suture holes in the stem to provide proper fixation. Suture pattern and method can be modified based on the condition of the fracture. The primary goal of tuberosity reattachment is to get as much contact with the stem, particularly the *Trabecular Metal* material, and the proximal humeral shaft while rebuilding into the anatomical position.

After the cement has hardened, two #5 braided nylon sutures each should be placed in the medial fin hole and the proximal shaft holes. Four sutures should already have been placed into the humeral shaft prior to cementing to act as vertical sutures which will aid in distal attachment of the tuberosities. Note: If insufficient bone stock is available in the shaft, the distal suture hole in the stem can be loaded with 2 sutures to provide an anchoring point for the vertical sutures. It is important to load and pass these sutures initially, as described below, as it may not be possible to place them after tuberosity reduction has been initiated (Figure 33). Any unused sutures can be removed and discarded after reduction.

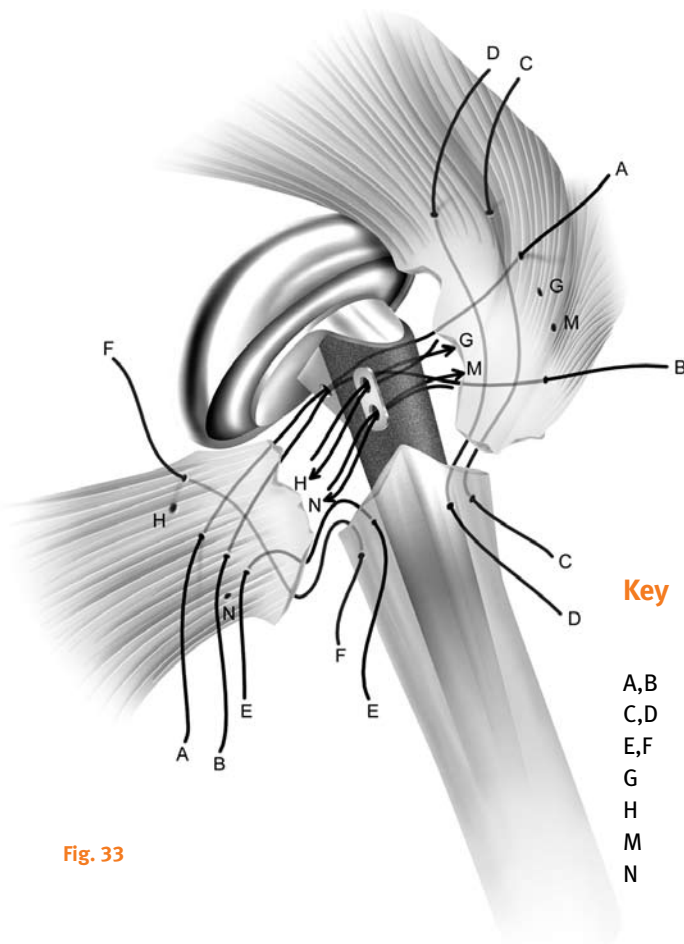

Fig. 33

Key

	Description	Hole location
A,B	Cerclage sutures	Medial fin hole
C,D	Greater tuberosity vertical sutures	Humeral bone shaft
E,F	Lesser tuberosity vertical sutures	Humeral bone shaft
G	Greater tuberosity fixation (if necessary)	Superior Stem hole
H	Lesser tuberosity fixation (if necessary)	Superior Stem hole
M	Greater tuberosity fixation (if necessary)	Inferior Stem hole
N	Lesser tuberosity fixation (if necessary)	Inferior Stem hole

The sutures in the medial fin hole (A & B) will initially be used to reduce the tuberosities to the shaft in a cerclage fashion. Note: Cerclage wire may be used instead of sutures but the size of wire used will dictate how many can be used. The cerclage sutures will be passed through the subscapularis tendon, at its insertion, wrap around the lesser and greater tuberosities and pass through the infraspinatus and teres minor at the tendon insertions. These sutures will be tightened and tied off first.

The sutures placed in the humeral shaft lateral to the biceps groove (C&D), will be passed through the supraspinatus tendon at its insertion and used to bring the distal edge of the greater tuberosity back down to the shaft. Note: Cancellous bone from the retrieved humeral head may be used to graft the upper shaft where the tuberosities will be placed. The sutures placed in the humeral shaft medial to the biceps groove (E&F), will be passed through the subscapularis at the tendon insertion and used to bring the distal edge of the lesser tuberosity back down to the shaft. These vertical sutures will be tightened and secured after the cerclage sutures are tied off. Note: If the most distal suture hole in the stem is used due to insufficient bone stock, these sutures will be used as the vertical sutures for the tuberosities and tied off at this time.

The sutures placed in the midline of the prosthesis are used to further reduce or compress the fragments against the *Trabecular Metal* material, if necessary. A suture from each hole (G&M) will be passed posteriorly through Infraspinatus and Teres minor insertions, respectively. The suture exiting anteriorly will pass around the greater tuberosity fragment and be tied down onto the greater tuberosity. If necessary, a second suture from each hole (H&N) will be passed posteriorly around the stem and medial fin through the subscapularis at its insertion. The suture end exiting anteriorly will be wrapped around the lesser tuberosity and tied down against the lesser tuberosity. Note: The anterior exiting sutures pass between the greater and lesser tuberosities along the fracture line, typically at the bicipital groove (Fig. 34). Remove and discard any unused sutures. Close the rotator interval from the edge of the supraspinatus to the upper edge of the subscapularis tendon.

Check stability and range of motion. If necessary, place bone graft from the humeral head in and around the tuberosity shaft interface.

If additional fixation is needed, the *Cable-Ready*® Grip System may be used. Pass a *Cable-Ready* Cable Grip System Cable inferiorly to superiorly around the rotator cuff insertion into the greater tuberosity (Fig. 35). Cross the cable inferiorly and pass it inferiorly to superiorly around the subscapularis insertion into the lesser tuberosity. Then tension the cable as desired and crimp it.

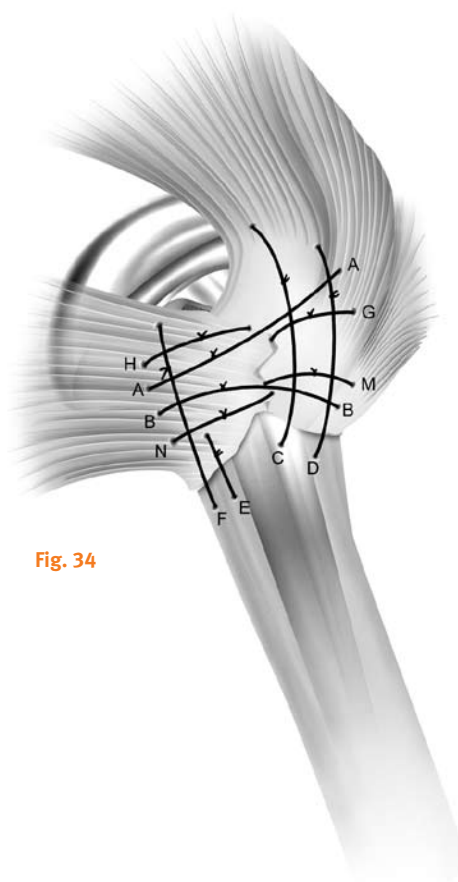

Fig. 34



Fig. 35

Humeral Head Removal

Should a humeral head ever have to be removed, slide the Head Distractor between the collar of the humeral stem and the undersurface of the humeral head (Fig. 36). Firmly tap the end of the instrument to loosen the head. This instrument can be used to remove either provisional heads or implants.



Fig. 36

Closure

If the biceps tendon was released, suture it to the pectoralis tendon. Then irrigate the wound and insert a *Hemovac*® Wound Drainage Device, being careful to avoid the axillary nerve. Close the subcutaneous layers, and then the skin.

Postoperative Management

On the first postoperative day, the patient typically begins hand and elbow motion, and passive shoulder range of motion. This should include pendulum exercises, elevation exercises, and external rotation exercises with a stick in the supine position and the arm slightly abducted. Passive elevation in the plane of the scapula is performed by the surgeon, a therapist, or a trained family member to a predetermined limit. The limits of postoperative motion are determined intraoperatively.

If the tuberosities are fragmented and osteoporotic, elevation in the scapular plane should be limited to about 90° or 100°, and gentle external rotation is allowed to about 10° or 20°. If the tuberosity repair is more secure, elevation to 140° and external rotation to 40° may be allowed. Motion is passive, and pulley exercises are usually avoided as these tend to cause some active use of the rotator cuff. Internal rotation, which can add tension to the greater tuberosity repair, should be avoided. The patient should continue exercises as an outpatient. At six to eight weeks, when some tuberosity healing is evident on radiographs, active exercises can begin, as well as increased range of motion stretches, including internal rotation.

Resistive strengthening exercises are gradually added. These exercises should emphasize stretching and balancing the range of motion. Strengthening is a secondary concern that need not be achieved until several months postoperatively.

Case Layouts

Trabecular Metal Humeral Instrument Set (00-4309-000-00)

Trabecular Metal Humeral Instrument Case (00-4309-095-00)

Top Tray

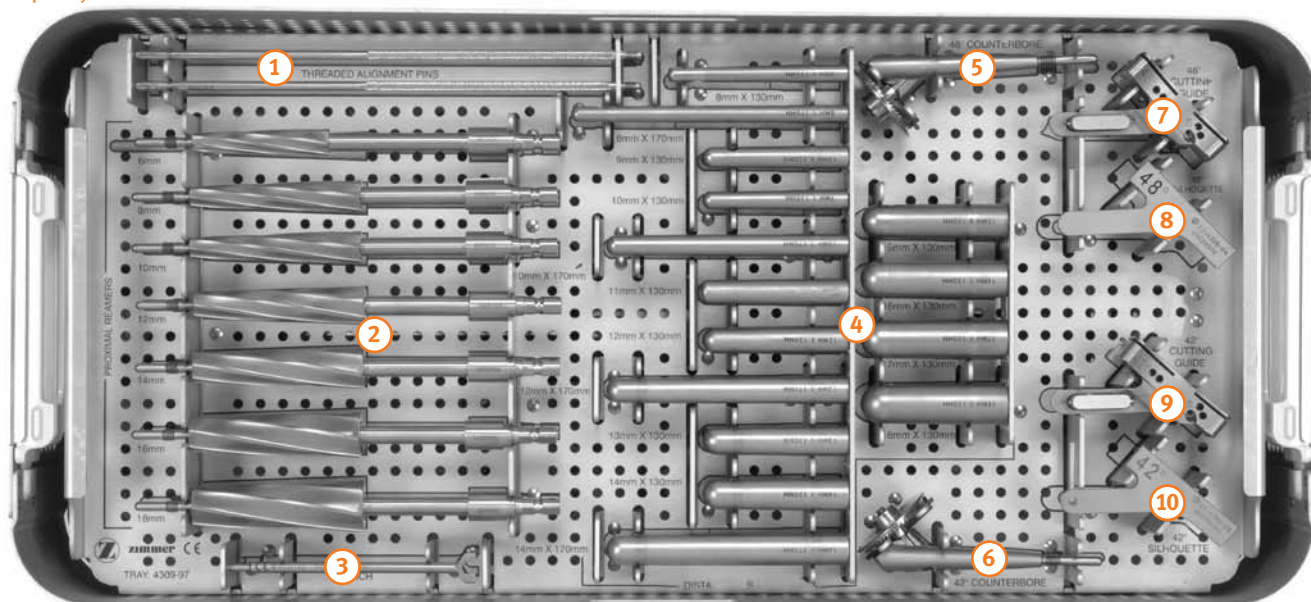

- | | | |
|---|---|---|
| 1 Threaded Alignment Rods (00-4309-009-00) | 5 48° Counterbore (00-4309-006-00) | 11 Left Fracture Instruments (00-4309-051-15,18,21) |
| 2 Proximal Reamers (00-4309-001-06/18) | 6 42° Counterbore (00-4309-005-00) | 12 Humeral Insertor (00-4309-007-00) |
| 3 Wrench (00-4301-033-00) | 7 48° Cutting Guide (00-4309-002-00) | 13 48° Proximal Trials (00-4309-018-06/18) |
| 4 130mm Distal Trials/Pilots (00-4309-008/018-13)
170mm Distal Trials/Pilots (00-4309-008/014-17) | 8 48° Silhouette (00-4309-004-00) | 14 42° Proximal Trials (00-4309-012-06/18) |
| | 9 42° Cutting Guide (00-4309-001-00) | 15 Right Fracture Instruments (00-4309-052-15,18,21) |
| | 10 42° Silhouette (00-4309-003-00) | |

Bottom Tray

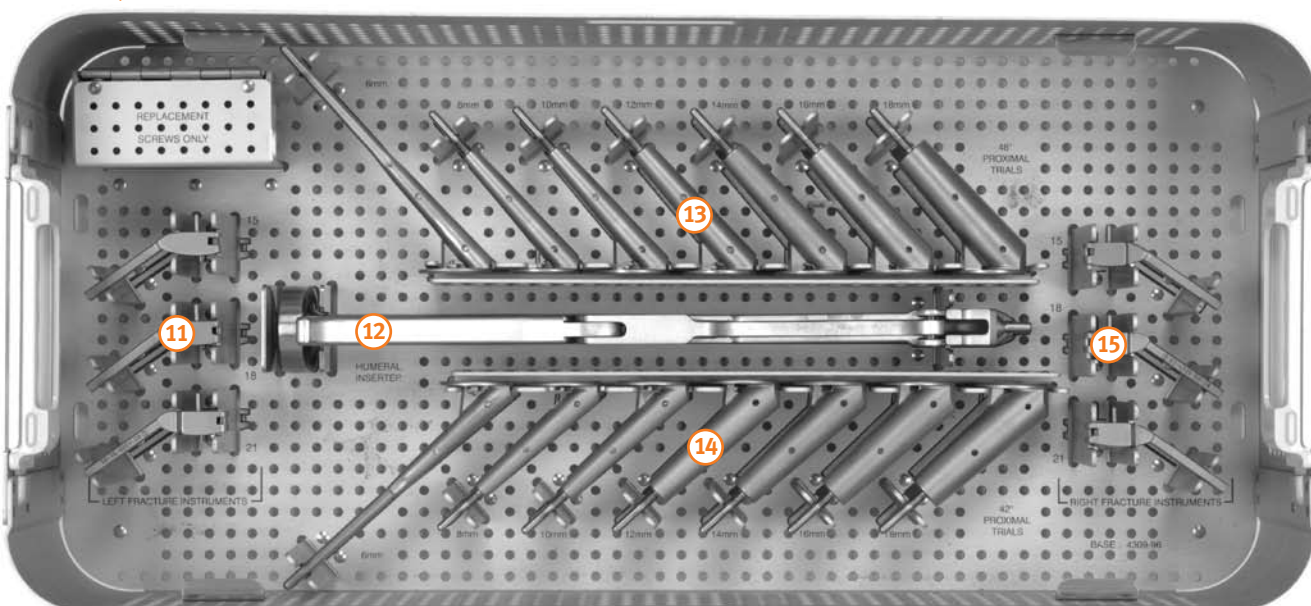

Note: Both of the 6mm Stem Trials are monoblock.

Case Layouts

Bigliani-Flatow Humeral Instrument Set (00-4300-000-13)

Instruments listed below will be used for this *Trabecular Metal* Humeral Stem Fracture Surgical Technique

Top Tray

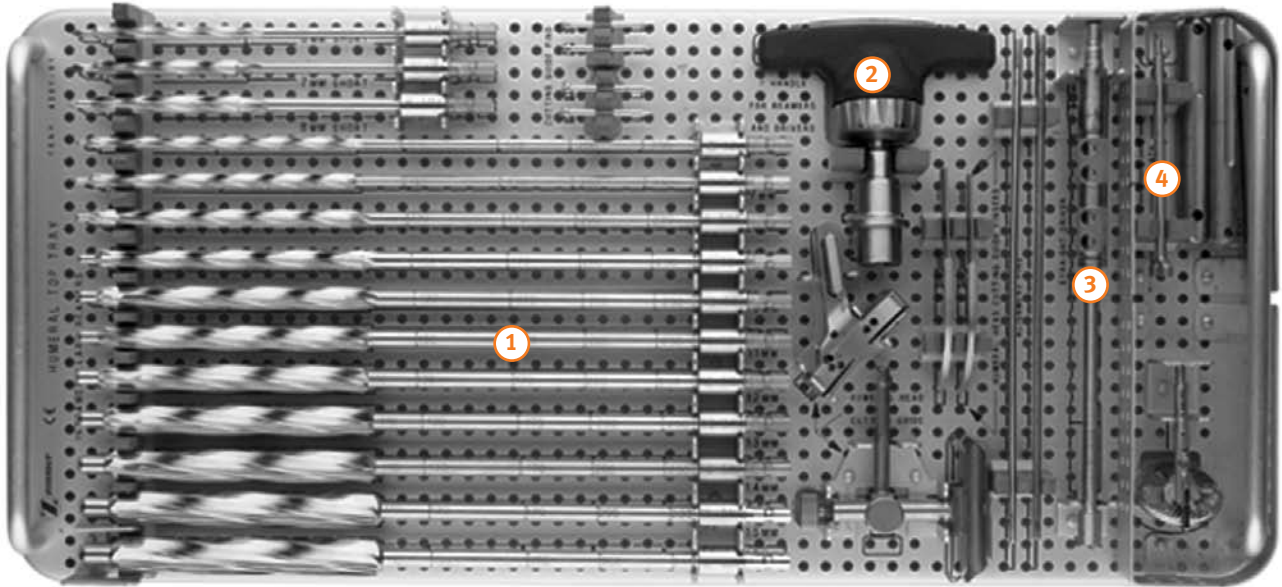

- 1 Intramedullary Reamers (00-4301-006/016-00)
- 2 T-Handle (for Reamers and Drivers) (00-4301-004-00)
- 3 Straight Driver (00-4301-073-00)
- 4 Wrench (00-4301-033-00)
- 5 Offset Head Provisional Set (00-4302-000-12)*
- 6 Head Distractor (00-8543-001-02)
- 7 Slaphammer (00-6601-004-00)
- 8 Provisional Capture Pins (00-4303-054-00)
- 9 Humeral Head Pusher (00-4301-022-00)

- 10 Offset Humeral Head Inserter (00-4303-075-00)*
- 11 Grooved Pin Inserter/Extractor (00-9305-030-20)

Bigliani/Flatow Fracture Instrument Set (00-4304-000-00)

- 12 Ruler (00-4304-002-00)
- 13 Pin Driver (00-4304-009-00)
- 14 3.2mm Threaded Pin (00-4304-008-00)

Bigliani/Flatow Fracture Instrument Tray (00-4304-090-00)

Bigliani/Flatow 17/18mm Humeral Instrument Set (00-4304-000-25)
(Not shown)

Intramedullary Reamers (00-4301-017/018-00)

Middle Tray

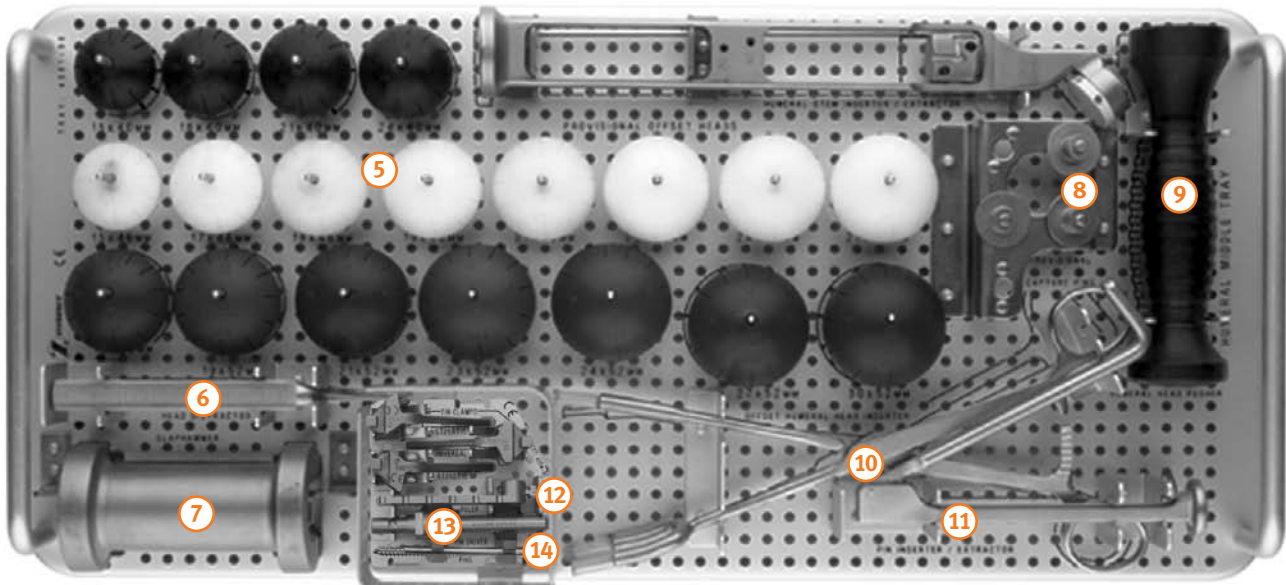

* Not included in the *Bigliani/Flatow* Humeral General Instrument Set.

Case Layouts

Bigliani-Flatow Humeral Instrument Set (00-4300-000-13), cont.

Instruments listed below will be used for this *Trabecular Metal* Humeral Stem Fracture Surgical Technique

Bottom Tray

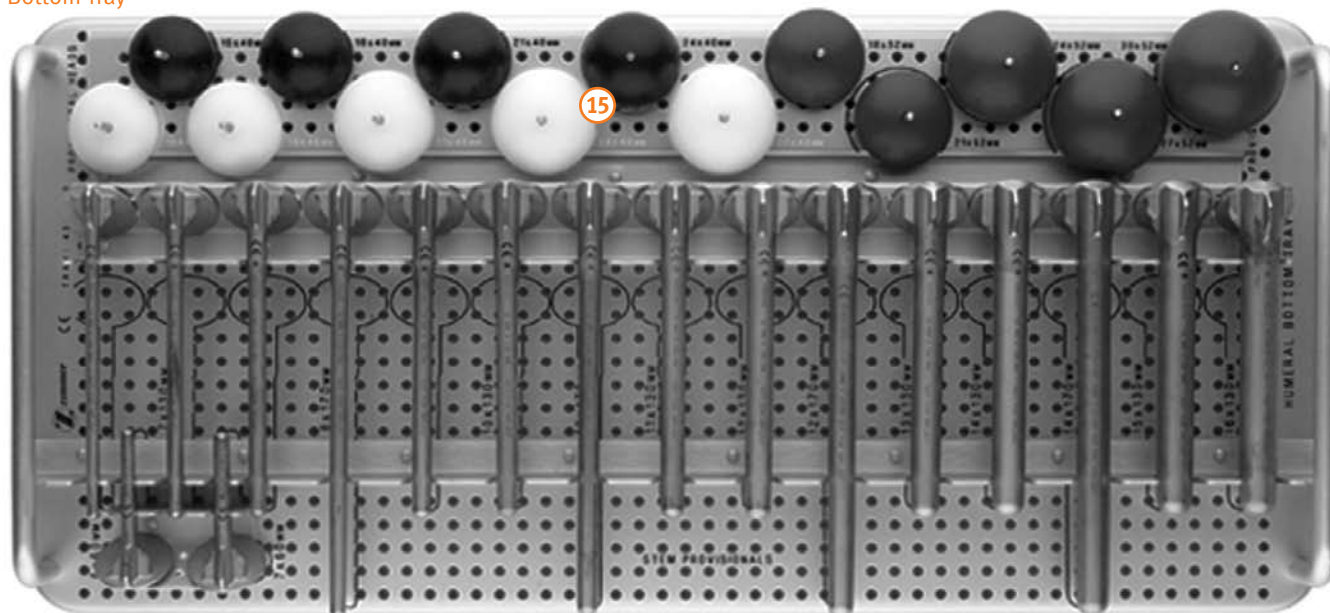

15 Standard Head Provisional Head Set (00-4300-000-17)*

Optional Set, Expanded Humeral Head Provisionals

Expanded Head Provisional Set (00-4300-000-24)

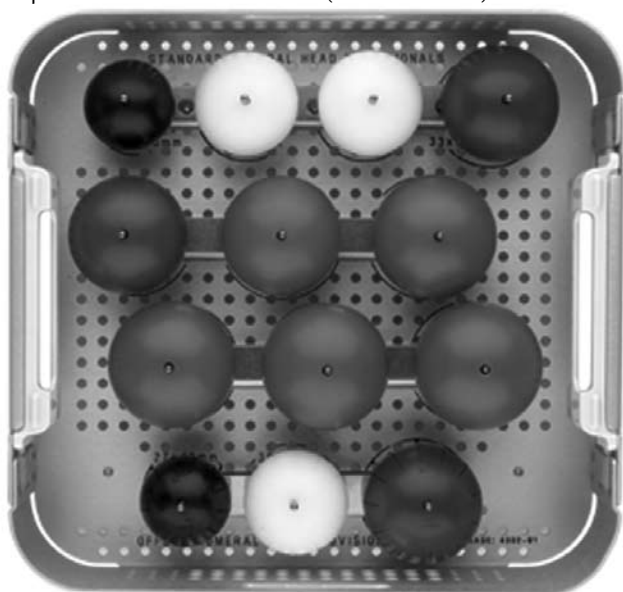

The following sets are not included in *Bigliani/Flatow* Humeral General Instrument set but can be ordered separately using the following set numbers or individual component numbers.

Bigliani/Flatow Fracture Instrument Set (00-4304-000-00)

Bigliani/Flatow 17/18mm Humeral Instrument Set (00-4304-000-25)

Offset Head Instrument Set (00-4302-000-11)

Offset Head Provisional Set (00-4302-000-12)

Standard Head Provisional Set (00-4300-000-17)

Expanded Head Provisional Set (00-4300-000-24)

* Not included in the *Bigliani/Flatow* Humeral General Instrument Set.







Contact your Zimmer representative or visit us at www.zimmer.com

