

TREE MORTALITY DURING EARLY FOREST DEVELOPMENT: A LONG-TERM STUDY OF RATES, CAUSES, AND CONSEQUENCES

JAMES A. LUTZ¹ AND CHARLES B. HALPERN

College of Forest Resources, Box 352100, University of Washington, Seattle, Washington 98195-2100 USA

Abstract. Tree mortality is a critical but understudied process in coniferous forest development. Current successional models assume that mortality during early forest development is dominated by density-dependent processes, but few long-term studies exist to test this assumption. We examined changes in forest structure and patterns of tree mortality 14–38 years (1979–2001) after clear-cut logging of two experimental watersheds in the western Cascade Range of Oregon, USA. We sampled 193 permanent plots (250 m²) six times generating 75 126 data records and 7146 incidents of mortality. Mean density peaked at >3000 stems/ha (≥ 1.4 m tall) after 22–25 years; bole biomass increased continuously to >100 Mg/ha. At final sampling, stem density varied by two orders of magnitude and biomass by a factor of 10 among sample plots. Suppression mortality occurred in >80% of plots and was >2.5 times as frequent as mechanical damage (uprooting, stem snap, and crushing). However, biomass lost to mortality via mechanical damage was nearly four times that lost to suppression, a result of episodic storms that created windthrow patches, with some plots losing 30–50% of biomass. Total annual mortality increased from 1.0% to 5.3% of stems over the study period and was highly variable among species. Although mortality rates were highest for sprouting hardwoods (reaching 9.7% in *Cornus nuttallii*), biomass of most hardwood species increased through canopy closure as dominant stems achieved large sizes. Shade-tolerant conifers (*Tsuga heterophylla* and *Thuja plicata*), typically assumed to be absent or to play a minor role in early forest development, accounted for 26% of stems after 38 years. In regression tree models, environmental attributes of plots had limited ability to predict mortality. Instead, stem density prior to canopy closure was the strongest predictor of cumulative mortality (either suppression or mechanical damage). Our long-term studies suggest that current models of early forest development are overly simplistic, particularly in their treatment of mortality. Although suppression was the dominant demographic process, mechanical damage yielded greater loss of biomass and greater structural heterogeneity through creation of windthrow gaps. Thus, gap-forming processes that operate late in succession and contribute to structural complexity in old-growth forests can also occur early in stand development.

Key words: disturbance; forest succession; gap formation; long-term studies; Pacific Northwest; permanent sample plot; *Pseudotsuga menziesii*; stand development; suppression; tree mortality; windthrow.

INTRODUCTION

Tree mortality plays a critical, but often oversimplified, role in forest development. It can facilitate turnover in species composition (Shugart et al. 1981, Runkle 2000), effect changes in forest structure (Christensen and Peet 1981, Franklin and Hemstrom 1981, Hibbs 1983), and alter rates of nutrient cycling or biomass accumulation (Marks and Bormann 1972, Marks 1974, Peet 1981, Bormann et al. 1995). The demographic and ecological consequences of mortality can vary profoundly, depending on the context, physical scale, and causes of death. Catastrophic wildfires and hurricanes induce dramatic changes in forest structure and function, resetting succession at large spatial scales (Foster 1988, Veblen et al. 1994, Turner et al. 1997). Gap-forming disturbances result in smaller, but locally

important changes (Runkle 1981, Canham 1989, Lertzman 1992, Wright et al. 2003). In contrast, gradual death of individual trees through physiological stress or competitive suppression may elicit only subtle responses of neighbors and negligible ecological effects.

In most forest ecosystems, detailed knowledge of the spatial and temporal dynamics of mortality and its causes are limited by two practical considerations: the life spans of most tree species and the infrequent or episodic nature of death. Dendroecological methods can be used to reconstruct mortality events and associated growth responses (Taylor and Halpern 1991, Mast and Veblen 1994, Winter et al. 2002a); however indeterminate amounts of mortality go undetected by these methods. Chronosequence studies can be used to characterize general trends in forest development (e.g., Spies and Franklin 1991, Drake and Mueller-Dombois 1993), but can offer only limited insights into the rates, causes, and ecological consequences of tree mortality. Few approaches can provide the direct evidence

Manuscript received 30 September 2005; revised 7 November 2005; accepted 14 November 2005. Corresponding Editor: T. P. Young.

¹ E-mail: jlutz@u.washington.edu



PLATE 1. An oblique aerial view of Watershed 1, H. J. Andrews Experimental Forest-LTER, Oregon, USA taken in 1988, 22 years after disturbance. The steeply dissected terrain is characteristic of much of the western Cascade Range. The north-facing slope is on the right, and the south-facing slope on the left. The lighter canopies evident on both sides of the watershed are *Acer macrophyllum*. The Andrews-LTER research facilities are visible in the lower left. Photo credit: USDA Forest Service.

afforded by long-term measurements (Munger 1946, Harcombe 1986, Condit 1998, Laurance et al. 2004).

In this study, we present 22 years of tree growth and mortality data from early successional forests dominated by Douglas-fir (*Pseudotsuga menziesii*) in two former old-growth watersheds in the western Cascade Range of Oregon. These data encompass a portion of the dynamic period of stand development known as “thinning” or “stem-exclusion” (Oliver 1981, Peet and Christensen 1987, Spies and Franklin 1996). Succession in these forests is typically portrayed as a relatively simple unidirectional process of growth and mortality (Oliver 1981, Peet 1981, Franklin et al. 2002) that includes (1) an “establishment” period dominated by shrubs and shade-intolerant hardwoods, (2) rapid growth of *Pseudotsuga* leading to

closure of the canopy and loss of hardwoods, and (3) intense intraspecific competition resulting in density-dependent mortality. It is generally assumed that hardwoods show limited persistence, that suppression is the dominant form of mortality, and that recruitment of shade-tolerant species does not occur until much later in succession (Oliver and Larson 1996, Franklin et al. 2002). In this paper we consider whether these assumptions constitute an overly simplistic model of forest development.

Although tree death is often the consequence of multiple factors or events (Manion 1981, Franklin et al. 1987), distinguishing among causes that arise from distinct physical or biological processes allows us to examine the attendant ecological outcomes. These causes can vary among species with different life

histories or canopy architectures (Foster 1988, Acker et al. 1996, 2003, Canham et al. 2001), and can change in importance during succession (Bible 2001, Canham et al. 2001). Suppression mortality is assumed to occur in all forests in which densities become high enough to induce competition for resources. A significant body of work has been devoted to this process in single-species stands (Yoda et al. 1963, Mohler et al. 1978, Kenkel 1988, Pittman and Turnblom 2003), but less to species mixtures (Binkley 2003, Canham et al. 2004). As a density-dependent process, suppression typically leads to more uniform spacing of trees (He and Duncan 2000, Gratzler and Rai 2004). Because species differ in their tolerance of shade, suppression can also lead to loss of diversity. However, because mortality is typically preceded by a gradual decline in vigor, the ecological effects of suppression can be subtle.

Pathogen- and insect-induced mortality can take many forms and affect forests at a variety of scales at various points in succession (Hansen and Goheen 2000, Rizzo et al. 2000, Piri 2003, Filip and Ganio 2004). In coastal forests of the Pacific Northwest, insect-induced mortality is relatively uncommon (Childs and Shea 1967); however, root and stem rots are frequent, particularly in older forests (Holah et al. 1997, Bible 2001).

Mortality induced by physical processes (e.g., wind, landslides, ice glazing, or snow loading) arises through infrequent storms that create small to large patches of mechanically damaged trees (Marks and Harcombe 1981, Rebertus et al. 1997, Sinton et al. 2000, Kramer et al. 2001) and sudden, often long-lasting changes in structure, resource availability, and microclimate (Bormann et al. 1995, Van Pelt and Franklin 2000, Gray et al. 2002).

In this paper, we explore changes in the composition and structure of young coniferous forests in the Pacific Northwest, how these are shaped by mortality and other processes, and what these changes imply for development of older forests. Considerable attention has been devoted to understanding the factors that contribute to structural complexity in old-growth forests in this region (Spies and Franklin 1989, Tappeiner et al. 1997, Franklin et al. 2002, Poage and Tappeiner 2002, Winter et al. 2002a, b, Weisberg 2004, Zenner 2005). The results of the current study suggest that some of this complexity may arise through mortality and other processes early in stand development. Our objectives are: (1) to quantify long-term changes in structure and composition in young coniferous forests, (2) to interpret these changes through the demography of individual tree species, and (3) to suggest how variation in the causes and spatial and temporal distributions of mortality contributes to the development of structure in older forests.

STUDY AREA

Physical environment

The study sites, Watersheds 1 (see Plate 1) and 3 (WS1 and WS3), are located in the H. J. Andrews Experimental Forest (HJA; 144°15' N, 122°12' W), 80 km east of

Eugene, Oregon, USA. The topography of these 100-ha basins is characteristic of much of the western Cascade Range, with steep dissected slopes separated by intermittent or perennial stream channels. Elevations range from 442 to 1082 m. Soils are primarily volcanic, originating from andesites, tuffs, breccias, and basalt flows and are shallow to moderately deep (Rothacher et al. 1967). Soil textures are loamy and moderately stony, and porosity and water-storage capacity are generally high (Dyrness 1969).

The climate is maritime with mild, wet winters and warm, dry summers. Average minimum temperatures are -5.5°C in January and 11.9°C in August; average maxima are 5.5°C in January and 23.3°C in July (HJA primary meteorological station, 420 m above sea level). Annual precipitation is 2300 mm, but only 6% falls between June and August (Bierlmaier and McKee 1989); below 1000 m, most precipitation falls as rain. Wind often accompanies winter precipitation, and exceptional winter storms characterized by very strong winds and heavy precipitation occur once or twice a decade (HJA long-term meteorological data, *available online*).²

Vegetation

WS1 and WS3 lie within the *Tsuga heterophylla* zone (Franklin and Dyrness 1988). Prior to logging, forests were dominated by old-growth (300–500-yr-old) and mature (125-yr-old) *Pseudotsuga menziesii*, with varying sizes and ages of *Tsuga heterophylla* and *Thuja plicata*. Common subcanopy species included the shade-tolerant conifer, *Taxus brevifolia*, and the hardwoods, *Acer macrophyllum*, *Cornus nuttallii*, and *Castanopsis chrysophylla*. Six understory plant communities were identified prior to disturbance, reflecting a strong gradient in soil moisture availability. From driest to wettest these were *Corylus cornuta*–*Gaultheria shallon*, *Rhododendron macrophyllum*–*Gaultheria shallon*, *Acer circinatum*–*Gaultheria shallon*, *Acer circinatum*–*Berberis nervosa*, *Coptis laciniata*, and *Polystichum munitum* (Rothacher et al. 1967, Dyrness 1973). Nomenclature follows Hitchcock and Cronquist (1973).

History of disturbance

Timing of logging and broadcast burning of slash differed between watersheds. The entire 96 ha of WS1 was clear-cut over a four-year period (1962–1966); logs were removed with skyline cables that required no road construction within the watershed. Residual slash was burned in October 1966. One-quarter of WS3 was clear-cut in three sections (5, 9, and 11 ha) over a single winter (1962–1963). A high-lead cable system was used to move logs to three roads constructed within the watershed. Slash was broadcast burned in September 1963, thus initiating succession three years earlier than in WS1.

² <http://www.fsl.orst.edu/lter/data/abstract.cfm?dbcode=MS001&topnav=97>

TABLE 1. Tree species observed on WS1 and WS3 (watersheds 1 and 3, H. J. Andrews Experimental Forest, Oregon, USA) with their maximum frequencies of occurrence (number of plots) during the study period (1979/1980–2001).

Species	Family	Maximum no. plots	
		WS1 (<i>n</i> = 132)†	WS3 (<i>n</i> = 61)
<i>Pseudotsuga menziesii</i>	Pinaceae	127	61
<i>Tsuga heterophylla</i>	Pinaceae	35	46
<i>Castanopsis chrysophylla</i>	Fagaceae	48	19
<i>Acer macrophyllum</i>	Aceraceae	46	17
<i>Cornus nuttallii</i>	Cornaceae	28	23
<i>Prunus emarginata</i>	Rosaceae	43	5
<i>Thuja plicata</i>	Cupressaceae	9	21
<i>Taxus brevifolia</i>	Taxaceae	3	21
<i>Arbutus menziesii</i>	Ericaceae	11	1
<i>Alnus rubra</i>	Betulaceae	5	4
<i>Rhamnus purshiana</i>	Rhamnaceae	4	1
<i>Abies amabilis</i>	Pinaceae	1	0
<i>Calocedrus decurrens</i>	Cupressaceae	1	0
<i>Populus trichocarpa</i>	Salicaceae	0	1

† Total number of plots.

Attempts at reforestation also differed between sites. In WS1, *Pseudotsuga menziesii* was aerially seeded in October 1967 and 10 ha were reseeded in October 1968. Stocking surveys revealed that establishment was poor and in April and May 1969, 2-yr-old *Pseudotsuga* were planted at 3-m spacing. Because of poor survival, 40 ha of the south-facing slope were replanted at 2.4 m spacing in April 1971. In WS3, 3-yr-old *Pseudotsuga* were planted between March and May 1964. Despite aerial seeding and planting, most *Pseudotsuga* regenerated through natural seeding (see *Discussion*).

METHODS

Sampling design and plot attributes

Circular sample plots of 250 m² were established in 1979 (WS3) and 1980 (WS1), 16 and 14 years after broadcast burning. Plot centers coincided with the locations of permanent understory quadrats established in 1962 (Dyrness 1973, Halpern 1988, 1989). In WS1, 132 plots were spaced at 30.5-m intervals along six widely spaced transects oriented perpendicular to the main stream channel. In WS3, 61 plots were similarly spaced along two to four transects per harvest unit. Because the focus was on upland forest development, plots that fell in perennial stream channels were not established, nor were plots on rock outcrops or roads (WS3). Sample plots comprise ~4% of the harvested areas of the two watersheds.

Prior to logging, understory quadrats were assigned to one of the six plant communities and one of six soil types reflecting variation in parent material, depth, and profile development (Rothacher et al. 1967, Dyrness 1969); tree plots were subsequently assigned the same classification. Spatial locations of plots were determined in 2004 using a differentially corrected Trimble GPS; plots were then placed on a 10-m digital elevation model from which elevation, aspect, and slope were derived (Lutz 2005).

Mean annual insolation was estimated for each plot based on a local model developed by Smith (2002).

Tree measurements

In this study, trees included all woody species characterized by one or few primary stems that exhibit strong apical dominance at maturity and have the potential to occupy canopy or subcanopy positions. At plot establishment, all trees ≥ 1.4 m tall were identified by species (Table 1) and measured in one of three ways. For conifers > 2 cm diameter at breast height (dbh), a numbered tag was nailed at breast height (1.37 m), and diameter was measured at the nail. For smaller trees, a tag was loosely wired onto a branch, and diameter was measured at the base of the tree (henceforth “dba stems”). Hardwood species often exhibited prolific basal sprouting, forming dense clumps (“clump stems”). Within each clump, stems ≥ 5 cm dbh were tagged (or if all stems were < 5 cm dbh, the largest was tagged) and smaller stems were tallied in two dbh classes (0.1–3.0 and 3.1–4.9 cm). Because it was not possible to consistently identify genets, we do not analyze the dynamics of individual clumps. All tagged stems were qualitatively rated for vigor: good, fair (significant loss or discoloration of foliage or physical damage), or poor (little foliage, mortality imminent). Additional notes were taken for stems with fair or poor vigor.

Plots were resampled in 1984, 1988, 1991, 1995, and 2001. At each remeasurement of tree diameter, tags on dba stems were moved to breast height, if possible, and measurements were taken at both heights. Previously tallied clump stems were tagged and measured if large enough. “Ingrowth” stems (previously < 1.4 m tall) were tagged and measured or tallied, as appropriate. A tagged stem that died since the last observation was measured for diameter and a cause of mortality was recorded. Although it can be difficult to identify the cause of mortality, it is possible to describe conditions at the time of death and thus to make reasonable inferences about cause. We adopted a classification system used in other long-term studies of western coniferous forests (Bible 2001, Pincheira 2004, van Mantgem et al. 2004), reducing a larger set of potential causes to one of six general forms that reflect distinct physical or biological processes:

1) Suppression: smaller stems in subordinate canopy positions that exhibited slow growth (i.e., minimal increment in diameter since the previous measurement and minimal leader or branch growth), but no sign of physical damage or pathogen activity.

2) Mechanical damage resulting from wind or snow loading: stems that were completely uprooted or whose boles were snapped or crushed beneath other uprooted or broken stems within the stand.

3) Crushed by old-growth trees: stems that were crushed by old-growth trees that fell into harvest units from adjacent forest.

4) Slope failure: uprooted stems associated with local slope failure.

5) Pathogens: two primary types of fungal pathogens were observed, root rots and dogwood anthracnose (*Discula destructiva*). Symptoms of root rot included gradual loss or chlorosis of needles in non-suppressed trees, absence of physical damage to boles or bark, and mortality often clumped in disease centers. Although field crews were unable to identify fungal species, we revisited several infection centers in 2004 and verified presence of *Armillaria ostoyae*, a native pathogen. Symptoms of the introduced pathogen, dogwood anthracnose, included distinctive brown spotting or senescence of leaves, with eventual dieback of twigs and entire stems. In addition to fungal pathogens, two instances of mortality attributed to hemlock dwarf mistletoe (*Arceuthobium tsugense*) were assigned to this category.

6) Animal damage: stems that exhibited obvious signs of browsing damage or stripping of bark and cambium.

If insufficient evidence existed to assign a cause, mortality was recorded as “unknown” (26% of cases).

Occasionally, a tagged stem was not found. If a stem remained missing for two sampling intervals it was assumed to have died during the first interval. Diameter was then assumed to be that of the last measurement and cause of mortality was inferred from evidence of disturbance (e.g., adjacent windthrow or slope failure) or previous comments; otherwise, mortality was recorded as unknown.

Data reduction and analysis

Plot-level summaries were computed for each species at each sampling date or measurement interval (for mortality rates). Of a total of 14 species, seven were too uncommon to warrant summary statistics (Table 1), but were included in plot totals. Summary statistics were generated for both live and dead stems on a slope-corrected basis, and included estimates of density, basal area, and bole biomass. To calculate basal area, clump stems were assigned diameter-class midpoints (1.5 or 4.0 cm). For dba stems, dbh was estimated from species-specific regression equations developed from stems that had been measured at both heights. Separate models were tested for each watershed, but only for *Pseudotsuga* did regression slopes differ significantly. Because trends in bole biomass paralleled those in basal area, for most analyses only biomass is presented.

To estimate bole biomass, we followed the methods of Acker et al. (2002). Three general approaches were used (for details see Lutz [2005]). For *Alnus rubra*, *Cornus nuttallii*, *Populus trichocarpa*, *Prunus emarginata*, and *Rhamnus purshiana*, bole biomass was estimated directly from dbh using regional equations in Means et al. (1994). For *Acer macrophyllum*, *Arbutus menziesii*, and *Castanopsis chrysophylla*, bole biomass was derived from volume equations based on dbh and height (Means et al. 1994), with heights estimated from dbh-height models of Garman et al. (1995). Standard values for wood density (M. Harmon, *personal communication*) were used to convert volume to mass (bark volume was

assumed to be negligible). For *Pseudotsuga menziesii*, *Thuja plicata*, and *Tsuga heterophylla*, wood biomass was estimated using local dbh-volume equations modified from those of Browne (1962) and paired measurements of dbh and height from local HJA data sets (Acker et al. 2002; S. A. Acker, *unpublished data*). Bark volume was estimated from species-specific bark: wood volume ratios (S. A. Acker, *unpublished data*). Source data are in the Oregon State University Forest Science Data Bank, data set TV009, *available online*.³ Standard values for bark and wood density were then used to convert volume to mass. For species lacking predictive equations, we substituted those of species with comparable growth form: *Pseudotsuga menziesii* for *Abies amabilis*; *Tsuga heterophylla* for *Taxus brevifolia* and *Calocedrus decurrens*; and *Alnus rubra* for *Cornus nuttallii*, *Prunus emarginata*, and *Rhamnus purshiana*.

To estimate species-specific rates of mortality and to partition mortality by cause, data were combined from both watersheds. Mortality rates were computed for each measurement interval, expressed on an annual basis (McCune and Cottam 1985, Sheil et al. 1995):

$$m = 100[1 - (N_t/N_0)^{1/t}] \quad (1)$$

where m is mortality rate (percentage of stems per year), N_0 is the number of stems alive at the previous measurement, N_t is the number of stems from the previous measurement alive at the current measurement, and t is the number of years between measurements. A similar equation was used to calculate the percentage of biomass lost per year. For hardwood species, these rates represent an underestimate of mortality: because clump stems (<5 cm dbh) were not tagged, it was not possible to quantify stem turnover (mortality and ingrowth). Mortality of these tallied stems was assumed only if the number of stems within a diameter class decreased between measurements (after considering the potential to advance to the larger class or to tagged status). However, if the number of stems within a class remained constant or increased, we assumed no mortality.

Regression trees (Breiman et al. 1984) were used to identify the environmental and biotic variables correlated with the two primary forms of mortality: suppression and mechanical damage. This method uses binary, recursive partitioning to split data into increasingly homogeneous subsets. For each plot, we summed the density of stems lost to suppression mortality or mechanical damage over the study period; these cumulative mortalities served as response variables. Regression-tree models were then run for each response variable. Four types of predictors were considered: (1) geographic/topographic variables, including watershed, elevation, slope, “northeastness” (aspect transformed as $\cos[\text{aspect} - 45^\circ]$), insolation ($\text{MJ}\cdot\text{m}^{-2}\cdot\text{day}^{-1}$; from Smith 2002), closest distance to forest edge, and closest

³ <http://www.fsl.orst.edu/lter/data/abstract.cfm?dbcode=TV009&topnav=97>

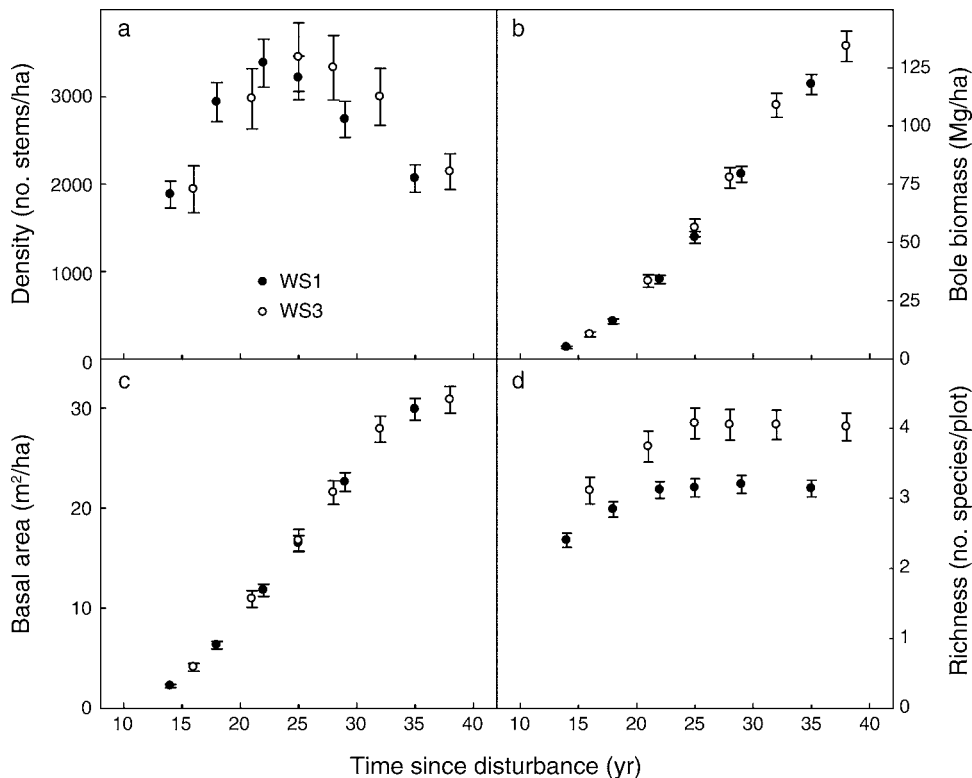

FIG. 1. Temporal trends (mean \pm SE) in (a) stem density, (b) bole biomass, (c) basal area, and (d) number of species per plot in WS1 ($n = 132$ plots) and WS3 ($n = 61$), watersheds 1 and 3, H. J. Andrews Experimental Forest, Oregon, USA. Due to the different dates of logging and broadcast burning of the watersheds, measurement years correspond to different times since disturbance.

distance to southern ridgeline; (2) soil type, reflecting differences in soil depth and potential for water retention; (3) plant community, a surrogate for site productivity; and (4) density of live stems at the first measurement.

For each response variable, an initial model was run with only "environmental" variables as predictors (1–3, above). A second model was then run that included density of live stems at the first measurement, with the expectation that "initial" density would correlate strongly with suppression-induced mortality. Regression trees were "pruned" using minimum-complexity criteria to eliminate branches that did not contribute significantly to reductions in deviance (Breiman et al. 1984). The addition of stem density improved models considerably, thus we present only the results of these second, more inclusive models.

RESULTS

Watershed-scale changes in forest structure and composition

Forest structure and composition changed markedly in both watersheds over the period of observation. Mean densities peaked at >3000 stems/ha (≥ 1.4 m tall) 22–25 yr after disturbance, then declined rapidly (Fig. 1a). At final sampling (35–38 yr), densities were comparable to those at initial measurement. Mean basal area and bole

biomass increased continuously, following nearly identical trajectories in the two watersheds (Fig. 1b, c). Species richness increased initially, but remained constant at three to four species per plot through final sampling (Fig. 1d).

Of 14 tree species observed, seven accounted for $>97\%$ of all stems and $>96\%$ of total biomass at each sampling date. *Pseudotsuga menziesii* was the dominant species, accounting for 50–58% of stems and 57–82% of biomass (Fig. 2a, b). Densities of the four hardwood species peaked early: *Cornus nuttallii* and *Acer macrophyllum* at 18–21 yr, and *Castanopsis chrysophylla* and *Prunus emarginata* at 22–25 yr (Fig. 2a). Densities of the two shade-tolerant conifers, *Tsuga heterophylla* and *Thuja plicata*, peaked later (29–32 yr), but declined during the last measurement interval. Nevertheless, at 35–38 yr, *Tsuga* accounted for 21% of stems (Fig. 2a).

Despite declines in density, most species showed continuous increases in bole biomass, albeit at varying rates (Fig. 2b). Of the subordinate species, *Tsuga* showed the most rapid accumulation of biomass, contributing 6% of total bole biomass at 35–38 yr. Among the hardwoods, *Acer* exhibited the highest rate of increase. *Prunus*, the only non-sprouting species, showed little change in biomass 29–32 yr after disturbance. *Cornus* was the only species that exhibited a decline in biomass during the sampling period.

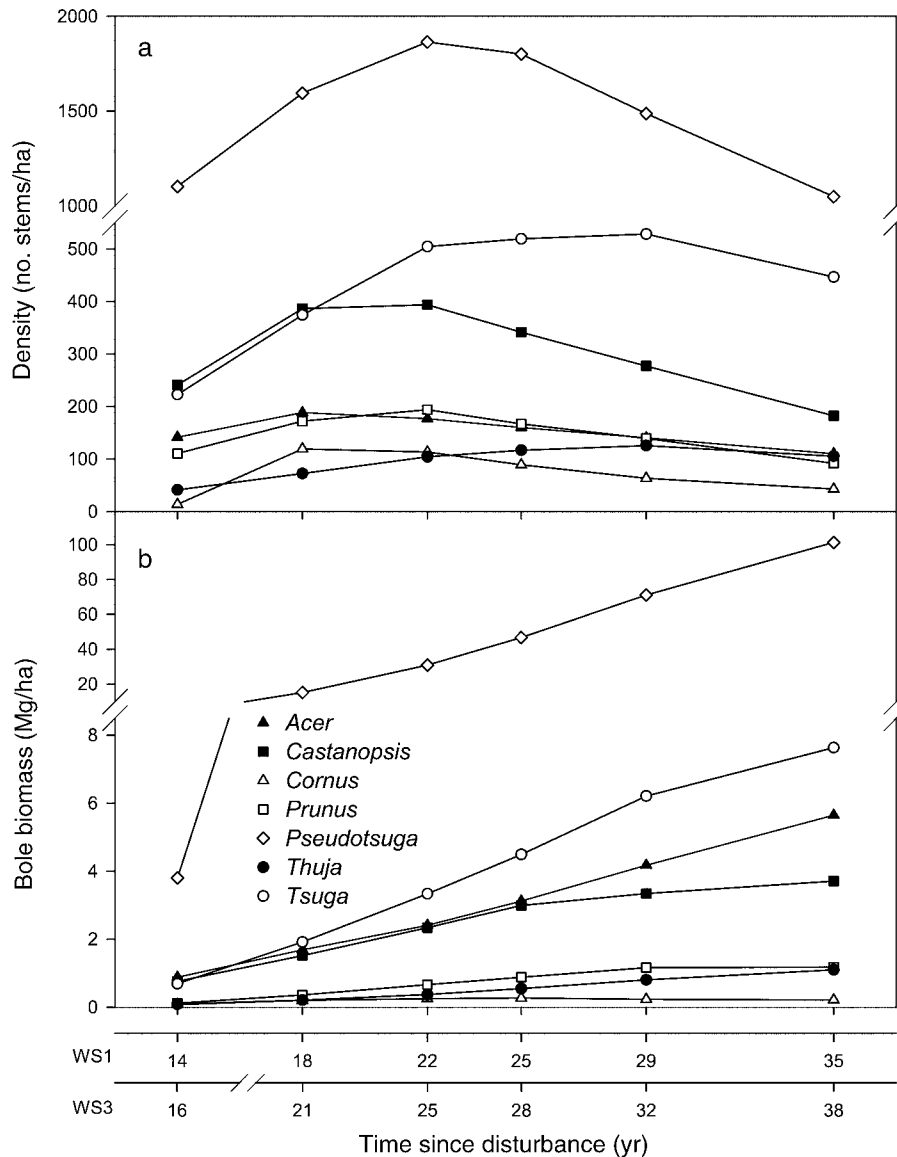

FIG. 2. Temporal trends in (a) stem density and (b) bole biomass for the seven common tree species. Data from both watersheds are combined ($n = 193$ plots). The x-axes represent time since disturbance for each watershed.

Plot-scale variation in forest structure and composition

Both watersheds showed a large range of variation in stem density and bole biomass among sample plots (Fig. 3). Even with the more extreme values excluded, density at final sampling varied by two orders of magnitude and bole biomass by a factor of 10. Similarly, the contributions of hardwoods and shade-tolerant conifers to total density and biomass varied markedly among plots and through time. Hardwoods were more prevalent on drier, south-facing slopes, and shade-tolerant conifers on north-facing slopes. Between the first and last measurements, the proportion of plots dominated by hardwoods decreased from 29% to 21% based on density and from 32% to 6% based on biomass (see Appendix). In contrast, the proportion of plots

dominated by shade-tolerant conifers nearly tripled for density (6% to 17%), but changed little for biomass (7% for both measurements).

Temporal trends in mortality

Total annual mortality increased over time from 1.0% to 5.3% of stems (Fig. 4a). As a percentage of total bole biomass, however, rates were low (<0.6%) and fairly constant until the last measurement interval (1.7%; Fig. 4b). All species showed proportionally greater mortality in numbers than in biomass (Fig. 4a, b), reflecting greater mortality of smaller stems. In fact, rates for hardwoods are likely to be considerably higher because of the conservative approach to estimating loss of clump stems (see *Methods: Data reduction and analysis*).

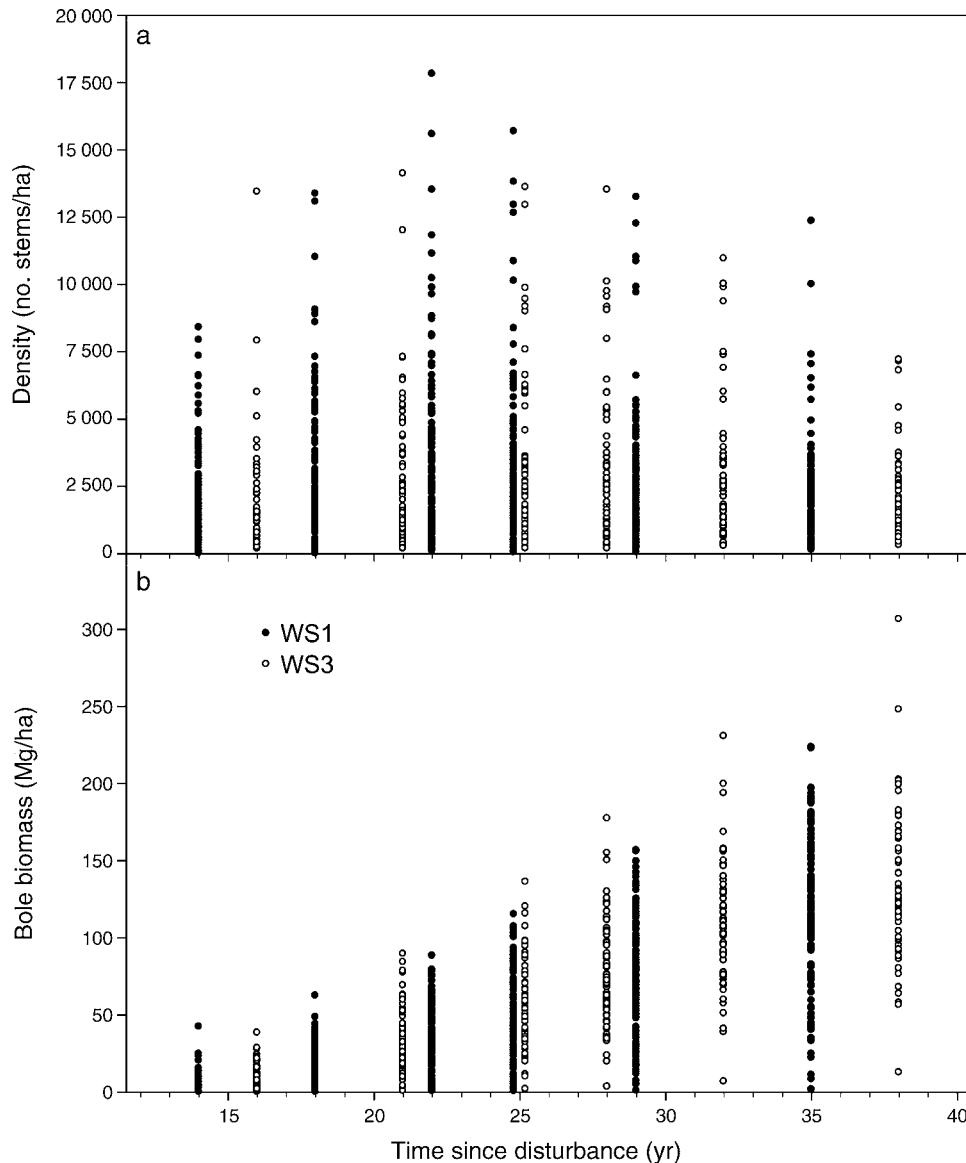

FIG. 3. Plot-level variation in (a) stem density and (b) bole biomass in WS1 and WS3 during each measurement year (time since disturbance).

Three temporal trends were observed among species. Hardwoods showed steep increases in mortality, peaking 18–25 yr after disturbance (Fig. 4a). The highest mortality rate among the hardwoods was for *Cornus* (exceeding 9.6% over a 7-yr period), and the lowest was for *Acer* (maximum of 5.4%). Mortality of *Pseudotsuga* increased more slowly, exceeding 5% after 25–28 yr. Mortality of shade-tolerant conifers (*Tsuga* and *Thuja*) was consistently low until the last measurement interval (29–38 yr) when rates increased to ~4%.

Trends in mortality expressed as a percentage of biomass were generally similar among species. *Cornus* and *Prunus*, however, exhibited distinctly greater proportional loss of biomass than did other species (Fig.

4b), reflecting a combination of higher rates of stem loss and greater loss of larger diameter stems.

Causes of mortality

Watershed-scale patterns.—Of a total of 7146 recorded incidents of mortality (tagged trees only), 26% could not be assigned a cause (Table 2). Among the remainder, suppression was the most frequent form of mortality (51% of tagged stems) and mechanical damage accounted for 18% of stems (Table 2). None of the remaining causes of mortality exceeded 2% of stems. A very different ranking of mortality emerged when expressed as loss of bole biomass: mechanical damage accounted for 51% of total mortality and suppression only 14% (Table 2). This reversal reflects the strong

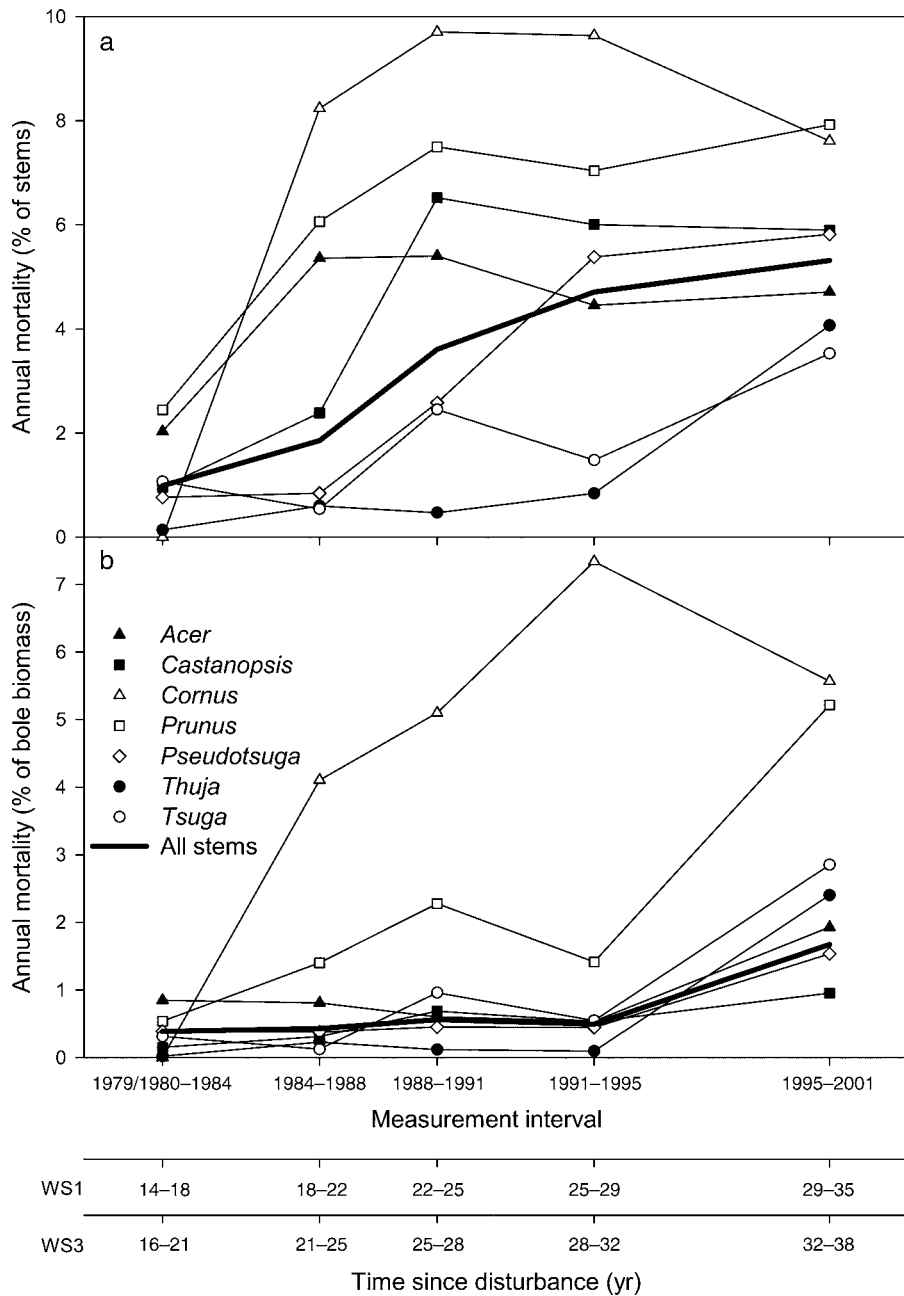

FIG. 4. Annual mortality rates of the seven common tree species and of all stems combined during each measurement interval. Rates are based on percentages of (a) stems and (b) bole biomass. See Fig. 2 for other details.

contrast in diameter distributions of populations lost to suppression and mechanical damage (Fig. 5). Suppression killed many small-diameter stems (quadratic mean diameter [QMD] of 3.4 cm); mechanical damage killed fewer, but considerably larger stems (QMD of 8.4 cm). Although a cause could not be assigned to one-quarter of all mortality, diameter distributions of unknown and “known” populations did not differ (Kolmogorov-Smirnoff test, $P = 0.50$). Thus, omission of unknown cases from these comparisons is not likely to bias our

estimates of suppression or mechanical damage. Pathogen-induced mortality accounted for 4% of total dead biomass and typically removed the largest trees (QMD of 11.3 cm).

Spatial distributions and temporal trends.—The primary causes of mortality showed considerable variation in space and time. Suppression mortality was broadly distributed across both watersheds (82% of plots). Rates of stem loss peaked between 25 and 32 yr, but loss of biomass increased continually as trees increased in size

TABLE 2. Annual mortality by cause during each sampling interval (years since disturbance in parentheses) expressed as stem density (top) and bole biomass (bottom).

Mortality cause	1979–1984 (14–21)	1984–1988 (18–25)	1988–1991 (22–28)	1991–1995 (25–32)	1995–2001 (29–38)	Total (14–38)
Density (no. stems·ha ⁻¹ ·yr ⁻¹)						
Suppression	0.8	3.8	44.3	88.5	56.9	41.7
Mechanical	2.2	0.9	21.8	7.6	33.0	15.1
Slope failure	0.2	0.4	1.8	0.3	5.0	1.9
Pathogen	t†	0.2	0.7	0.6	1.4	0.7
Animal	0.1	0.1	0.7	0.4	0.3	0.3
Old growth‡	4.8	2.5	0.2	0.4	0.0	1.6
Unknown	9.7	25.5	13.4	25.1	24.2	21.1
Total	17.8	33.2	82.9	122.9	120.8	82.4
Bole biomass (Mg·ha ⁻¹ ·yr ⁻¹)						
Suppression	t	0.002	0.030	0.104	0.168	0.075
Mechanical	0.003	0.002	0.125	0.043	0.840	0.276
Slope failure	t	0.001	0.005	0.003	0.050	0.016
Pathogen	t	0.014	0.015	0.019	0.042	0.021
Animal	t	t	0.001	0.014	0.008	0.005
Old growth	0.010	0.008	0.001	0.001	0.000	0.004
Unknown	0.011	0.053	0.039	0.105	0.334	0.138
Total	0.025	0.079	0.216	0.290	1.443	0.536

Notes: Succession in WS3 was initiated three years prior to WS1. However, the first sampling of WS3 was one year before the first sampling of WS1. Second and subsequent samplings occurred simultaneously (see *Study area: History of disturbance and Methods: Sampling design and plot attributes*).

† Abbreviation “t” indicates “trace” (for density, <0.1 stems·ha⁻¹·yr⁻¹; for biomass, <0.001 Mg·ha⁻¹·yr⁻¹).

‡ Crushed beneath old-growth trees.

(Table 2). In contrast, mortality attributable to physical causes was spatially patchy and episodic. Mechanical damage occurred in 56% of plots, with 86% of stems and 98% of biomass lost during two of the five sampling intervals (Table 2). These losses reflect the effects of major winter storms preceding the 1991 and 2001 measurements. Mortality attributable to slope failure was also episodic and localized, occurring in 5% of plots. In addition, two old-growth trees fell into harvest units from adjacent forest during the first two sampling intervals. Although these events affected only four plots, they accounted for 8–27% of dead stems and 10–40% of dead biomass during these early measurement intervals (Table 2). In both instances, a number of damaged trees succumbed to mortality in subsequent intervals.

Pathogen-induced mortality was limited in time and space. Loss of *Cornus* to dogwood anthracnose was not recorded until the second decade of observation and in only 7% of plots that contained *Cornus*. Loss of *Pseudotsuga* to root rot (primarily *Armillaria ostoyae*) was not significant until the final sampling interval (29–35 yr) and was restricted to 5% of plots (primarily at the top of WS1). Thirteen plots (7%) had no mortality during the study period.

The proportion of plots that experienced major (>20%) declines in stem density between measurements increased with time, with losses due to a combination of suppression and mechanical damage (Fig. 6, left panel). Declines in biomass were less frequent: most plots exhibited increases of 20–60%. However, the frequency of decline increased with time and was attributable solely to mechanical damage (Fig. 6, right panel).

Species differences.—Causes of mortality varied sig-

nificantly among species. Three general patterns were observed. Among hardwoods, suppression was by far the dominant form of mortality, both in numbers and biomass (Table 3). Moreover, although a large proportion of hardwood mortality was recorded as unknown, it was likely due to suppression because there was no evidence of physical damage or disease. For *Pseudotsuga*, suppression was three times more frequent than mechanical damage, but mechanical damage yielded more than four times the loss of bole biomass. Mortality of the shade-tolerant conifers, *Tsuga* and *Thuja*, was dominated by mechanical damage, both in numbers and biomass (Table 3).

Environmental and biotic correlates of mortality

The regression-tree analyses of cumulative mortality produced very different models for suppression and mechanical damage. In the suppression model (86% reduction in deviance; Fig. 7a), mortality was partitioned by initial density at several levels (greater at higher density), aspect (greater on north and east aspects), and insolation (greater in shadier plots), with a small proportion of deviance explained by plant community. In the mechanical-damage model (58% reduction in deviance; Fig. 7b), the first partition was also on stem density, but it accounted for considerably less of the total deviance explained. Additional significant predictors included aspect (greater on north and east aspects), watershed (greater in WS3 than WS1), and soil type (lower on stony soils and talus, but with little explanatory power). With these variables in the models, slope, distance to forest edge, and distance to

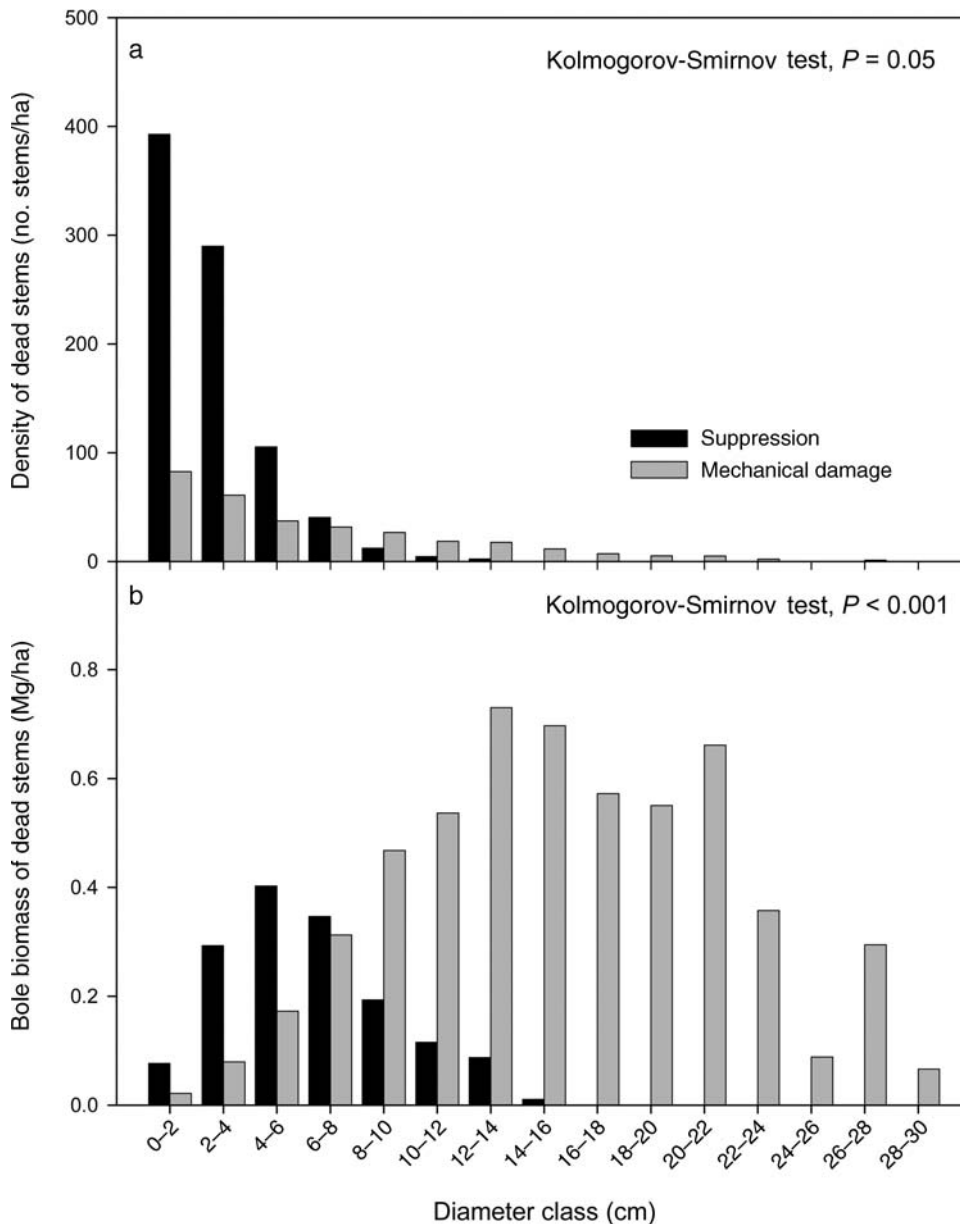

FIG. 5. Diameter class distributions of stems lost to suppression and mechanical damage over the study period (1979/1980–2001) for both watersheds combined.

southern ridgeline were not significant predictors in either model.

DISCUSSION

Our long-term study provides abundant evidence that current models of forest succession paint an overly simplistic picture of the early development of *Pseudotsuga* forests. More than two decades of density, growth, and mortality data reveal spatial and temporal variation that are not possible to discern from space-for-time substitutions. Sample plots followed multiple trajectories of structural development, reflecting variation in initial composition, recruitment, and timing and

causes of mortality. The spatial, temporal, and environmental breadth of these data allows us to reexamine many of the assumptions and uncertainties implicit in current successional models. At the same time, we recognize that this represents a single study of two watersheds and care must be taken in generalizing to other forest types or to stands with distinctly different disturbance histories.

Changes in composition and structure during early stand development

It is generally assumed that, if present in the species pool, early successional hardwoods dominate the initial

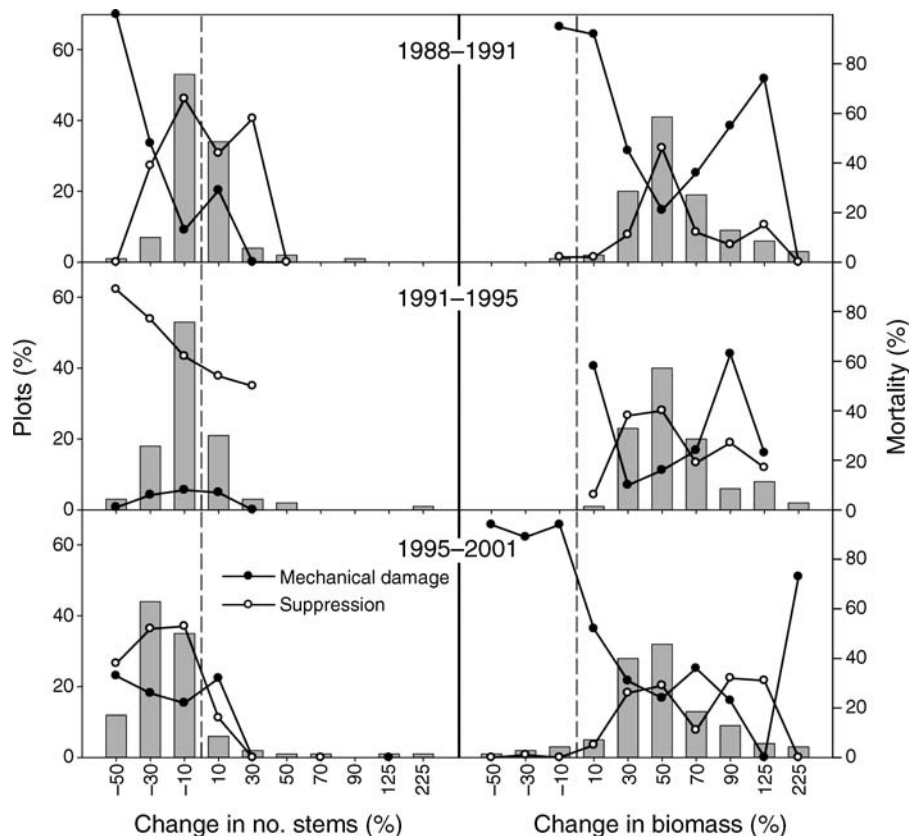

FIG. 6. Percentage of plots (left axis) showing declines and increases in stem density (histograms, left) and bole biomass (histograms, right) during each of the last three measurement intervals. Lines indicate the relative contribution of suppression (open circles) and mechanical damage (solid circles) to mortality (right axis) within each set of plots. Dashed vertical lines separate negative and positive changes in density or biomass. Abscissa values represent midpoints of 20% classes (except for 125 [100–150%] and 225 [150–300%]). Data from both watersheds are combined.

stages of stand development, either through vegetative sprouting (e.g., McKee 1990, Minore and Zasada 1990, Harrington and Tappeiner 1997) or recruitment and rapid growth of seedlings (Marks 1974, Harrington 1990). Both strategies were evident in this study: abundant basal sprouting of *Acer*, *Castanopsis*, and *Cornus*, and locally dense establishment of *Prunus* from a persistent soil seed bank (Oakley and Franklin 1998). However, dominance by hardwoods in this study was largely restricted to south-

facing slopes and areas with shallower soils. *Alnus rubra*, which has the potential for abundant recruitment and early dominance in more coastal forests in this region (Hibbs and Bower 2001, Binkley 2003), was largely restricted to riparian habitats in our sites.

Given the inherent trade-off between rapid juvenile growth and longevity (Grime 1979), we expected hardwoods to peak in density and biomass prior to canopy closure, then to decline with closure of the canopy by

TABLE 3. Percentage of mortality attributed to suppression (Supp.), mechanical damage (Mech.), and unknown (Unkn.) for the seven common tree species over the study period (1979/1980–2001).

Species	n	Stems (%)			Bole biomass (%)		
		Supp.	Mech.	Unkn.	Supp.	Mech.	Unkn.
<i>Prunus emarginata</i>	710	42.9	6.5	49.3	51.1	12.5	33.9
<i>Castanopsis chrysophylla</i>	578	48.5	2.6	48.4	49.5	13.2	35.6
<i>Cornus nuttallii</i> †	117	35.6	9.7	47.8	25.3	9.0	48.8
<i>Acer macrophyllum</i>	316	26.3	13.6	58.4	11.0	10.5	78.1
<i>Pseudotsuga menziesii</i> ‡	4399	59.3	18.8	18.5	12.5	58.0	22.6
<i>Thuja plicata</i>	144	21.1	67.7	11.3	2.6	94.5	2.9
<i>Tsuga heterophylla</i>	804	29.1	51.5	13.2	6.1	75.6	15.8

Note: Values are numbers of tagged stems that died (n) and percentages of stems and bole biomass.

† For *Cornus*, a pathogen (dogwood anthracnose) was responsible for mortality of 6.0% of stems and 16.3% of biomass.

‡ For *Pseudotsuga*, pathogens (root rot) were responsible for mortality of 1.0% of stems and 4.8% of biomass.

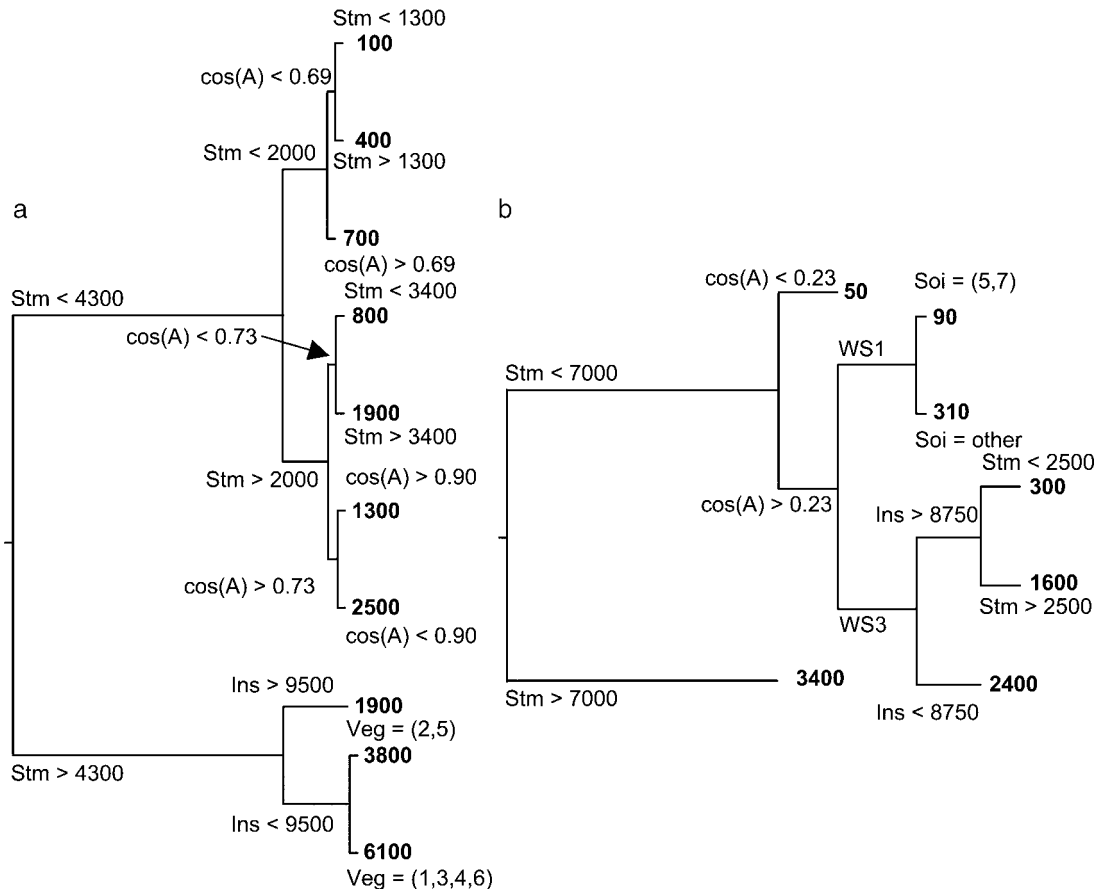

FIG. 7. Regression-tree results illustrating the distribution of mortality in both watersheds. Separate models are shown for (a) suppression (86% reduction in deviance) and (b) mechanical damage (58% reduction in deviance) based on environmental and biotic predictors. Values in bold at the ends of the trees are cumulative mortalities (no. stems/ha) over the study period (1979/1980–2001). Threshold values for predictors are shown along the branches. Predictors are coded as: cos(A), cosine transformation of aspect (see *Methods: Data reduction and analysis*); Ins, insolation ($\text{MJ}\cdot\text{m}^{-2}\cdot\text{d}^{-1}$); Soi, soil type (1, Frissell/McKenzie River; 2, Limberlost; 3, Andesite colluvium; 4, Budworm/Slipout; 5, Stony Frissell/Stony Limberlost; 6, Talus; Rothacher et al. [1967]); Stm, stem density (no. stems/ha); Veg, plant community (1, *Corylus cornuta-Gaultheria shallon*; 2, *Rhododendron macrophyllum-Gaultheria shallon*; 3, *Acer circinatum-Gaultheria shallon*; 4, *Acer circinatum-Berberis nervosa*; 5, *Coptis laciniata*; 6, *Polystichum munitum*); WS1/WS3, watershed. The length of horizontal line segments in each tree is proportional to the proportion of deviation explained.

Pseudotsuga. However, long-term trends revealed a somewhat surprising result. Species richness did not decline and, although densities declined after an early peak (18–25 yr), biomass increased consistently for nearly all species of hardwoods. Deciduous (*Acer*) and evergreen (*Castanopsis* and *Arbutus*) species showed similar growth patterns: vigorous basal sprouting, differential growth of neighboring shoots, and gradual “self-pruning” of smaller, subordinate stems. Surviving stems of *Acer* were particularly large, forming tall and very broad canopies, often to the exclusion of other species. Not only did biomass increase continuously, but for *Acer* and *Castanopsis*, mortality rates during the last measurement interval were less than, or comparable to, rates for *Pseudotsuga*. Clearly, presence in the pre-disturbance community, ability to accumulate biomass during canopy closure, declining mortality rates, and longevities spanning centuries (Keeler-Wolf 1988,

McKee 1990) suggest the potential for persistence of hardwoods in these forests well past canopy closure (see also Grier and Logan [1977]).

The early establishment and abundance of shade-tolerant conifers in these forests also contrasts with traditional stand development models. Recruitment following large-scale disturbance is typically assumed to take decades, if not centuries (Oliver and Larson 1996, Acker et al. 1998a, Franklin et al. 2002), limited by environmental or edaphic constraints, size or intensity of disturbance, or seed source (Harmon and Franklin 1989, Busing et al. 1995, Beach and Halpern 2001, Keeton and Franklin 2005). Yet, in fewer than four decades on our sites, *Tsuga* comprised >20% of all stems and as a group, shade-tolerant conifers dominated nearly 20% of plots by density. In fact, in some plots, *Tsuga* was dominant at every measurement. Rapid establishment of *Tsuga* was facilitated by the proximity and abundance of

old-growth seed sources along harvest-unit boundaries, particularly on cooler, moister, north-facing slopes. Occasional advanced regeneration was also observed, primarily in microsites that escaped broadcast burning (Halpern 1989). These refugia were very important for *Taxus*, whose dispersal potential is poor; once extirpated, reestablishment in the forest understory can take centuries (Busing et al. 1995).

Plot-level variation in simple measures of structure (stem density and biomass) highlight extreme spatial heterogeneity in the pace and intensity of canopy closure in these forests. This runs counter to the common perception (one likely shaped by the "plantation" model of stand development) that canopy closure occurs uniformly and rapidly in *Pseudotsuga* forests. In these watersheds, some plots regenerated quickly and densely to well over 5000 stems/ha; others showed little if any regeneration even after 35 years. Accumulation of bole biomass showed similar variation among plots. Plots with relatively low densities were more likely to occur on drier, south-facing slopes with shallower soils. Plots with unusually high densities were more common on north-facing slopes or near harvest-unit boundaries where seed rain from adjacent old growth was abundant. This spatial heterogeneity of forest structure suggests that "horizontal diversification" in older forests (typically associated with gap-forming processes late in stand development [Franklin et al. 2002]) may begin considerably earlier through processes unrelated to mortality.

Mortality patterns and processes

Estimates of total annual stem mortality in these forests were generally high, exceeding 5% during the fourth decade of stand development. These represent mean rates derived from measurement intervals of 3–6 years, but annual variability may have been higher, particularly following years with severe storm events. Early rates of mortality also differed markedly among species with different life histories: higher among hardwoods than shade-tolerant conifers and intermediate for *Pseudotsuga* (Fig. 4). Interestingly, however, there was a noticeable convergence in mortality rates over time. This reflects two phenomena: (1) stabilizing or declining rates among hardwood clumps that experienced more intensive "self-thinning" earlier in succession, and (2) a noticeable increase in mortality of shade-tolerant conifers, not through suppression, but through crushing disturbance. Annual mortality of *Pseudotsuga* increased to >5% during the fourth decade, perhaps approaching its peak rate in these forests. In 45- to 80-yr-old stands of similar composition, annual mortality of *Pseudotsuga* was considerably lower (1.1–2.9%; Bible 2001). In mature and old-growth *Pseudotsuga*/*Tsuga* forests, rates appear to stabilize at ~0.5–0.9% (DeBell and Franklin 1987, Bible 2001). Comparable mortality rates have been reported in mature and old *Picea*/*Tsuga* forests of the coastal Northwest (1.0–1.8%; Harcombe 1986, Pincheira 2004), deciduous forests of eastern North America (0.5–

1.4%; Runkle 2000, Busing 2005), and a >1100-yr-old *Sequoia sempervirens* forest in northern California (0.3%; Busing and Fujimori 2002).

The results of this study support the conventional view that suppression is the most common form of mortality during early stand development. Suppression was observed in >80% of plots and was more than 2.5 times as frequent as mechanical damage (uprooting, stem snap, and crushing). However, biomass lost to mechanical damage was nearly four times that lost to suppression. The differing ecological consequences of suppression and mechanical damage underscore the need to distinguish between the two. Suppression typically killed smaller hardwoods and *Pseudotsuga* through a gradual process of decline that released few resources, and likely led to greater uniformity of spacing (Kenkel 1988, He and Duncan 2000, Harris 2004). In contrast, mechanical damage was spatially patchy and episodic, associated with two major winter storms (1991 and 1996; Table 2). In both instances, trees were uprooted, snapped, or crushed, creating gaps of varying size with some plots losing as much as 30–50% of biomass during the last sampling interval (Fig. 8). Due to their canopy architecture and needle retention, conifers were more susceptible than hardwoods to snow loading and high winds (Boerner et al. 1988, Foster 1988) and thus suffered greater mechanical damage. *Tsuga* and *Thuja*, which were common in the subcanopy, were primarily lost through crushing disturbance.

Effects of wind and ice storms have been studied extensively in other North American forest types (e.g., Foster 1988, Foster and Boose 1992, Greenberg and McNab 1998, Platt et al. 2000, Lafon 2004, Ryall and Smith 2005). Wind storms and snow loading of forest canopies occur frequently enough in the Pacific Northwest (Marks et al. 1998; HJA long-term meteorological data, see footnote 2) to have the potential to induce significant mechanical damage in young forests. However, gap formation via wind or snow loading has not been considered an important ecological process in young *Pseudotsuga* forests (but see Acker et al. 2003). Damage is more likely to occur in older (and taller) forests, which experience greater wind speed at greater height, and in denser stands in which increasing height:diameter ratios lead to greater instability (Wilson and Archer 1979, Foster 1988, Mitchell et al. 2001). During the 1996 storm captured in the current study, deep snow had accumulated at low elevations, loading the canopies of *Pseudotsuga*. This was followed by strong wind and intense persistent rain, saturating soils and destabilizing root systems. Clearly, the convergence of multiple stressors in time and space increased the likelihood of mechanical damage.

A winter storm in 2003, subsequent to the last measurement, enlarged these openings along unstable edges, illustrating the potential for continued gap expansion as these forests mature (Sprugel 1976, Young and Hubbell 1991, Wilson and Oliver 2000, Harcombe et



Fig. 8. A gap created by windthrow/snow loading in 1996 in WS3; photo taken in 2004.

al. 2004). The future of these gaps remains uncertain. Some are large enough to facilitate recruitment of most tree species (including *Pseudotsuga*), but it is possible that further regeneration will be limited by competitive understory species (e.g., Veblen 1989, Rebertus et al. 1997). Some may transition to dominance by shade-tolerant conifers: where they were crushed but not uprooted, *Tsuga*, *Thuja*, and *Taxus* reoriented branches and needles to take advantage of increases in light, an adaptation to physical damage experienced in the understory of old-growth forests. Thus, gap formation has the potential to locally reset or advance succession (Stewart 1986, Foster 1988, Canham 1989, Spies et al. 1990, Holah et al. 1997, Wright et al. 2003). This represents another mechanism (in addition to the spatial variability in initial establishment), by which horizontal diversification may occur relatively early in forest development.

Regression-tree models supported our expectation that density-dependent mortality would be highly correlated with stem density prior to canopy closure. In contrast, environmental and edaphic attributes had less predictive value, although they may influence mortality indirectly through effects on tree recruitment and survival (and thus stem density). For mechanical damage, we expected stronger physical controls associated with aspect (related to directionality of prevailing winds and distance to ridgelines), soil type (affecting

root system depth and stability), and harvest unit size (as it influences wind speed and turbulence) (Ruel et al. 1998, Savill 1998, Sinton et al. 2000). Although mechanical damage tended to occur in patches, and relationships to aspect and size of harvest units were consistent with expectation, these environmental predictors contributed minimally to variation in mortality. Instead, as with the suppression model, initial stem density was the strongest predictor of mechanical damage. Although this outcome may simply reflect the fact that more stems can die where stem densities are higher, a biotic mechanism is equally plausible: tree stability is often reduced at higher densities (Cremer et al. 1982, Mitchell et al. 2001). Ultimately, mechanical damage is likely to reflect the interaction of physical and biotic factors and it may be difficult to tease apart these effects in steep and heavily dissected landscapes where wind behavior, soil stability, and stand structure can vary at small spatial scales.

For the conifer species, root-rot pathogens contributed minimally to tree mortality. Where present, however, root rot invariably killed larger *Pseudotsuga*, often in small groups, consistent with typical patterns of infection and spread. However, rates of mortality can be considerably greater in similar forests of this region (Childs 1970, Hansen and Goheen 2000, Filip and Ganio 2004). Pathogens played a more prominent role

in the dynamics of *Cornus*, the only species to show a decline in biomass over the course of study. More than 16% of its dead biomass was attributable to infection by anthracnose. Moreover, some of the early mortality recorded as unknown was probably due to anthracnose that had not been recognized. Anthracnose has been documented as a primary agent of mortality in dogwood throughout the midwestern and eastern United States (Carr and Banas 2000, Jenkins and White 2002). Although it has been observed on *Cornus nuttallii* in western forests (Salogga 1982), its distribution and ecological influence have not been described. This is the first study to quantify the demographic effects of infection in young forests of this region.

Relevance of postharvest dynamics to natural successional processes

To what extent are developmental patterns in these clear-cut, burned, and planted watersheds relevant to understanding natural successional processes in *Pseudotsuga* forests? Clearly, catastrophic fire would have left considerably more structure (primarily in the form of snags) and greater heterogeneity of post-disturbance environments, including patches of intact forest. Large areas of residual forest adjacent to WS1 and within WS3 may have functioned in similar ways, providing shade and an abundance of seed (Acker et al. 1998b, Keeton and Franklin 2005). Natural seeding combined with widespread failure of artificial seeding and planting (particularly on WS1) resulted in a regeneration process shaped, in large part, by natural establishment. Although we cannot determine the origins of individual trees, early reports of germination and data from stocking surveys (see Lutz [2005]) confirm that most *Pseudotsuga* originated from natural seeding. Shortly after planting, seedling densities were estimated at 270 (WS1) and 415 seedlings/ha (WS3) compared to average densities of *Pseudotsuga* of 1948 and 1680 seedlings/ha in 1988.

Fragmentation and toppling of snags and fire-scarred trees have the potential to enhance structural diversity and locally reset succession in young forests. In this study, the mortality caused by old-growth trees falling from adjacent forests offers insight into the importance of these processes. Trees that were crushed accounted for a large proportion of the stems and biomass lost during early sampling intervals. Historically, where catastrophic fire left a legacy of snags and damaged trees, falling boles could have been a significant source of mortality, and one that played out over decades. In the current managed landscape where snags are typically felled during timber harvest or salvaged after wildfire (McComb et al. 1993, Franklin et al. 2002), they play a relatively limited role.

Metrics of mortality and their ecological implications

Tree mortality is typically viewed from a demographic perspective, and hence mortality is usually expressed by changes in stem density. However, our results point to a

critical distinction between the demographic and ecological consequences of mortality. In these forests, suppression was the primary cause of mortality among hardwoods, whether it was expressed in numbers or biomass. Among shade-tolerant conifers, mechanical damage dominated both measures of mortality. For both groups, neither the causes nor the consequences of death were contingent on the metric of mortality. This was not the case for the dominant species, *Pseudotsuga*. Suppression dominated as a demographic process and mechanical damage in structural or ecological terms. This contrast underscores the value of long-term population studies in testing basic assumptions about successional processes—in this case, the assumption that suppression is the “dominant” form of mortality in young, closed-canopy forests. Furthermore, the importance of mechanical mortality in young forests serves to blur the distinctions among developmental “stages” in these forests, emphasizing instead the continuity of pattern and process (Franklin et al. 2002). Gap formation that contributes to the structural complexity of old growth (Spies and Franklin 1991, Franklin et al. 2002, Franklin and Van Pelt 2004) can also be active in young forests.

ACKNOWLEDGMENTS

Jerry Franklin initiated this study by expanding on permanent plots established by Ted Dyrness in 1962. We thank Steven Acker, Richard Brainerd, Howard Bruner, and Mark Klopsch for their contributions to data collection and oversight of field crews. Many others assisted with field measurements, but are too numerous to name. We thank Gody Spycher for assistance with database management and quality assurance. Steven Acker, Jerry Franklin, Paul Harcombe, Don McKenzie, Douglas Sprugel, and two anonymous reviewers provided critical reviews that greatly improved earlier drafts of this manuscript. Funding was provided by USDA Forest Service, PNW Research Station (01-CA-112619522-223); the National Science Foundation (DEB-0218088); and a Byron and Alice Lockwood Fellowship (College of Forest Resources, University of Washington) awarded to James Lutz.

LITERATURE CITED

- Acker, S. A., S. V. Gregory, G. Lienkaemper, W. A. McKee, F. J. Swanson, and S. D. Miller. 2003. Composition, complexity, and tree mortality in riparian forests in the central western Cascades of Oregon. *Forest Ecology and Management* **173**:293–308.
- Acker, S. A., C. B. Halpern, M. E. Harmon, and C. T. Dyrness. 2002. Trends in bole biomass accumulation, net primary production and tree mortality in *Pseudotsuga menziesii* forests of contrasting age. *Tree Physiology* **22**:213–217.
- Acker, S. A., M. E. Harmon, T. A. Spies, and W. A. McKee. 1996. Spatial patterns of tree mortality in an old-growth *Abies–Pseudotsuga* stand. *Northwest Science* **70**:132–138.
- Acker, S. A., T. E. Sabin, L. M. Ganio, and W. A. McKee. 1998a. Development of old-growth structure and timber volume growth trends in maturing Douglas-fir stands. *Forest Ecology and Management* **104**:265–280.
- Acker, S. A., E. K. Zenner, and W. H. Emmingham. 1998b. Structure and yield of two-aged stands on the Willamette National Forest, Oregon: implications for green tree retention. *Canadian Journal of Forest Research* **28**:749–758.
- Beach, E. W., and C. B. Halpern. 2001. Controls on conifer regeneration in managed riparian forests: effects of seed

- source, substrate, and vegetation. *Canadian Journal of Forest Research* **31**:471–482.
- Bible, K. J. 2001. Long-term patterns of Douglas-fir and western hemlock mortality in the western Cascade Mountains of Washington and Oregon. Dissertation. University of Washington, Seattle, Washington, USA.
- Bierlmaier, F. A., and A. McKee. 1989. Climatic summaries and documentation for the primary meteorological station, H. J. Andrews Experimental Forest, 1972 to 1984. USDA Forest Service General Technical Report PNW-GTR-242.
- Binkley, D. 2003. Seven decades of stand development in mixed and pure stands of conifers and nitrogen-fixing red alder. *Canadian Journal of Forest Research* **33**:2274–2279.
- Boerner, R. J., S. D. Runge, D. Cho, and J. G. Kooser. 1988. Localized ice storm damage in an Appalachian plateau watershed. *American Midland Naturalist* **119**:199–208.
- Bormann, B. T., H. Spaltenstein, M. H. McClellan, F. C. Ugolini, K. Cromack, Jr., and S. M. Nay. 1995. Rapid soil development after windthrow disturbance in pristine forests. *Journal of Ecology* **83**:747–757.
- Breiman, L., J. H. Friedman, R. Olshen, and C. J. Stone. 1984. Classification and regression trees. Wadsworth and Brooks/Cole, Pacific Grove, California, USA.
- Browne, J. E. 1962. Standard cubic foot volume tables for commercial tree species of British Columbia. British Columbia Forest Service, Victoria, British Columbia, Canada.
- Busing, R. T. 2005. Tree mortality, canopy turnover, and woody detritus in old cove forests of the southern Appalachians. *Ecology* **86**:73–84.
- Busing, R. T., and T. Fujimori. 2002. Dynamics of composition and structure in an old *Sequoia sempervirens* forest. *Journal of Vegetation Science* **13**:785–792.
- Busing, R. T., C. B. Halpern, and T. A. Spies. 1995. Ecology of Pacific yew (*Taxus brevifolia*) in western Oregon and Washington. *Conservation Biology* **9**:1199–1207.
- Canham, C. D. 1989. Different responses to gaps among shade-tolerant tree species. *Ecology* **70**:548–550.
- Canham, C. D., P. T. LePage, and K. D. Coates. 2004. A neighborhood analysis of canopy tree competition: effects of shading versus crowding. *Canadian Journal of Forest Research* **34**:778–787.
- Canham, C. D., M. J. Papaik, and E. F. Latty. 2001. Interspecific variation in susceptibility to windthrow as a function of tree size and storm severity of northern temperate tree species. *Canadian Journal of Forest Research* **31**:1–10.
- Carr, D. E., and L. E. Banas. 2000. Dogwood anthracnose (*Discula destructiva*): effects of and consequences for host (*Cornus florida*) demography. *American Midland Naturalist* **143**:169–177.
- Childs, T. W. 1970. Laminated root rot of Douglas-fir in western Oregon and Washington. USDA Forest Service Research Paper PNW-102.
- Childs, T. W., and K. R. Shea. 1967. Annual losses from disease in Pacific Northwest forests. USDA Forest Service Resource Bulletin PNW-20.
- Christensen, N. L., and R. K. Peet. 1981. Secondary forest succession on the North Carolina Piedmont. Pages 230–245 in D. C. West, H. H. Shugart, and D. B. Botkin, editors. *Forest succession*. Springer-Verlag, New York, New York, USA.
- Condit, R. 1998. Tropical forest census plots: methods and results from Barro Colorado Island, Panama and a comparison with other plots. Springer, New York, New York, USA.
- Cremer, K. W., C. J. Brough, F. H. McKinnel, and P. R. Carter. 1982. Effects of stocking and thinning on wind damage in plantations. *New Zealand Journal of Forest Science* **12**:245–268.
- DeBell, D. S., and J. F. Franklin. 1987. Old-growth Douglas-fir and western hemlock: a 36-year record of growth and mortality. *Western Journal of Applied Forestry* **2**:111–114.
- Drake, D. R., and D. Mueller-Dombois. 1993. Population development of rain forest trees on a chronosequence of Hawaiian lava flows. *Ecology* **74**:1012–1019.
- Dyrness, C. T. 1969. Hydrological properties of soils on three small watersheds in the western Cascades of Oregon. USDA Forest Service Research Note PNW-111.
- Dyrness, C. T. 1973. Early stages of plant succession following logging and burning in the western Cascades of Oregon. *Ecology* **54**:57–69.
- Filip, G. M., and L. M. Ganio. 2004. Early thinning in mixed-species plantations of Douglas-fir, hemlock, and true fir affected by *Armillaria* root disease in westcentral Oregon and Washington: 20 year results. *Western Journal of Applied Forestry* **19**:25–33.
- Foster, D. R. 1988. Species and stand response to catastrophic wind in central New England, U.S.A. *Journal of Ecology* **76**:135–151.
- Foster, D. R., and E. R. Boose. 1992. Patterns of forest damage resulting from catastrophic wind in central New England, USA. *Journal of Ecology* **80**:79–98.
- Franklin, J. F., and D. S. DeBell. 1988. Thirty-six years of tree population change in an old-growth *Pseudotsuga-Tsuga* forest. *Canadian Journal of Forest Research* **18**:633–639.
- Franklin, J. F., and C. T. Dyrness. 1988. Natural vegetation of Oregon and Washington. Oregon State University Press, Corvallis, Oregon, USA.
- Franklin, J. F., and M. A. Hemstrom. 1981. Aspects of succession in the coniferous forests of the Pacific Northwest. Pages 212–229 in D. C. West, H. H. Shugart, and D. B. Botkin, editors. *Forest succession*. Springer-Verlag, New York, New York, USA.
- Franklin, J. F., H. H. Shugart, and M. E. Harmon. 1987. Tree death as an ecological process. *BioScience* **27**:550–556.
- Franklin, J. F., et al. 2002. Disturbances and structural development of natural forest ecosystems with silvicultural implications, using Douglas-fir as an example. *Forest Ecology and Management* **155**:399–423.
- Franklin, J. F., and R. Van Pelt. 2004. Spatial aspects of structural complexity in old-growth forests. *Journal of Forestry* **102**:22–28.
- Garman, S. L., S. A. Acker, J. L. Ohmann, and T. A. Spies. 1995. Asymptotic height-diameter equations for twenty-four species in western Oregon. Research Contribution 10. Oregon State University Forest Research Lab, Corvallis, Oregon, USA.
- Gratzer, G., and P. B. Rai. 2004. Density-dependent mortality versus spatial segregation in early life stages of *Abies densa* and *Rhododendron hodgsonii* in central Bhutan. *Forest Ecology and Management* **192**:143–159.
- Gray, A. N., T. A. Spies, and M. J. Easter. 2002. Microclimatic and soil moisture responses to gap formation in coastal Douglas-fir forests. *Canadian Journal of Forest Research* **32**:332–343.
- Greenberg, C. H., and W. H. McNab. 1998. Forest disturbance in hurricane-related downbursts in the Appalachian Mountains of North Carolina. *Forest Ecology and Management* **104**:179–191.
- Grier, C. C., and R. S. Logan. 1977. Old-growth *Pseudotsuga menziesii* communities of a western Oregon watershed: biomass distribution and production budgets. *Ecological Monographs* **47**:373–400.
- Grime, J. P. 1979. Plant strategies and vegetation processes. John Wiley and Sons, New York, New York, USA.
- Halpern, C. B. 1988. Early successional pathways and the resistance and resilience of forest communities. *Ecology* **69**:1703–1715.
- Halpern, C. B. 1989. Early successional patterns of forest species: interactions of life history traits and disturbance. *Ecology* **70**:704–720.
- Hansen, E. M., and E. M. Goheen. 2000. *Phellinus weirii* and other native root pathogens as determinants of forest

- structure and process in western North America. *Annual Review of Phytopathology* **38**:515–539.
- Harcombe, P. A. 1986. Stand development in a 130-year-old spruce-hemlock forest based on age structure and 50 years of mortality data. *Forest Ecology and Management* **14**:41–58.
- Harcombe, P. A., S. E. Greene, M. G. Kramer, S. A. Acker, T. A. Spies, and T. Valentine. 2004. The influence of fire and windthrow dynamics on a coastal spruce-hemlock forest in Oregon, USA, based on aerial photographs spanning 40 years. *Forest Ecology and Management* **194**:71–82.
- Harmon, M. E., and J. F. Franklin. 1989. Tree seedlings on logs in *Picea sitchensis*-*Tsuga heterophylla* forests of Washington and Oregon. *Ecology* **70**:48–49.
- Harrington, C. A. 1990. *Alnus rubra* Bong. Red Alder. Pages 116–123 in R. M. Burns and B. H. Honkala, editors. *Silvics of North America*. USDA Agricultural Handbook 654. Volume 2: Hardwoods. USDA, Washington, D.C., USA.
- Harrington, T. B., and J. C. Tappeiner, II. 1997. Growth responses of young Douglas-fir and tanoak 11 years after various levels of hardwood removal and understory suppression in southwestern Oregon, USA. *Forest Ecology and Management* **96**:1–11.
- Harris, M. 2004. The importance of competition processes and canopy gaps in the development of old-growth *Pseudotsuga/Tsuga* forests. Thesis. University of Washington, Seattle, Washington, USA.
- He, F., and R. P. Duncan. 2000. Density-dependent effects on tree survival in an old-growth Douglas-fir forest. *Journal of Ecology* **88**:676–688.
- Hibbs, D. E. 1983. Forty years of forest succession in central New England. *Ecology* **64**:1394–1401.
- Hibbs, D. E., and A. L. Bower. 2001. Riparian forests in the Oregon Coast Range. *Forest Ecology and Management* **154**:201–213.
- Hitchcock, C. L., and A. Cronquist. 1973. *Flora of the Pacific Northwest*. University of Washington Press, Seattle, Washington, USA.
- Holah, J. C., M. V. Wilson, and E. M. Hansen. 1997. Impacts of a native root-rotting pathogen on successional development of old-growth Douglas-fir forests. *Oecologia* **111**:429–433.
- Jenkins, M. A., and P. S. White. 2002. *Cornus florida* L. mortality and understory composition changes in western Great Smoky Mountains National Park. *Journal of the Torrey Botanical Society* **129**:194–206.
- Keeler-Wolf, T. 1988. The role of *Chrysolepis chrysophylla* (Fagaceae) in the *Pseudotsuga*-hardwood forest of the Klamath Mountains of California. *Madroño* **35**:285–308.
- Keeton, W. S., and J. F. Franklin. 2005. Do remnant old-growth trees accelerate rates of succession in mature Douglas-fir forests? *Ecological Monographs* **75**:103–118.
- Kenkel, N. C. 1988. Pattern of self-thinning in jack pine: testing the random mortality hypothesis. *Ecology* **69**:1017–1024.
- Kramer, M. G., A. J. Hansen, M. L. Taper, and E. J. Kissinger. 2001. Abiotic controls on long-term windthrow disturbance and temperate rain forest dynamics in southeast Alaska. *Ecology* **82**:2749–2768.
- Lafon, C. W. 2004. Ice-storm disturbance and long-term forest dynamics in the Adirondack Mountains. *Journal of Vegetation Science* **15**:267–276.
- Laurance, W. F., A. A. Oliveira, S. G. Laurance, R. Condit, H. E. M. Nascimento, A. C. Sanchez-Thorin, T. E. Lovejoy, A. Andrade, S. D'Angelo, J. E. Ribeiro, and C. W. Dick. 2004. Pervasive alteration of tree communities in undisturbed Amazonian forests. *Nature* **428**:171–175.
- Lertzman, K. P. 1992. Patterns of gap-phase replacement in a subalpine, old-growth forest. *Ecology* **73**:657–669.
- Lutz, J. A. 2005. The contribution of mortality to young coniferous forest development. Thesis. University of Washington, Seattle, Washington, USA.
- Manion, P. D. 1981. *Tree disease concepts*. Prentice-Hall, Englewood Cliffs, New Jersey, USA.
- Marks, D., J. Kimball, D. Tingey, and T. Link. 1998. The sensitivity of snowmelt processes to climate conditions and forest cover during rain-on-snow: a case study of the 1996 Pacific Northwest flood. *Hydrological Processes* **12**:1569–1587.
- Marks, P. L. 1974. The role of pin cherry (*Prunus pensylvanica* L.) in maintenance of stability in northern hardwood ecosystems. *Ecology* **44**:73–88.
- Marks, P. L., and F. H. Bormann. 1972. Revegetation following forest cutting: mechanisms for return to steady-state nutrient cycling. *Science* **176**:914–915.
- Marks, P. L., and P. A. Harcombe. 1981. Forest vegetation of the big thicket, southeast Texas. *Ecological Monographs* **51**:287–305.
- Mast, J. N., and T. T. Veblen. 1994. A dendrochronological method of studying tree mortality patterns. *Physical Geography* **15**:529–542.
- McComb, W., T. A. Spies, and W. H. Emmingham. 1993. Douglas-fir forests: managing for timber and mature-forest habitat. *Journal of Forestry* **91**:31–42.
- McCune, B., and G. Cottam. 1985. The successional status of a southern Wisconsin oak woods. *Ecology* **66**:1270–1278.
- McKee, W. A. 1990. *Castanopsis chrysophylla* (Dougl.) A. DC. Giant chinquapin. Pages 234–239 in R. M. Burns and B. H. Honkala, editors. *Silvics of North America*. USDA Agriculture Handbook 654. Volume 2: Hardwoods. USDA, Washington, D.C., USA.
- Means, J. E., H. A. Hansen, G. J. Koerper, P. B. Alaback, and M. W. Klopsch. 1994. Software for computing plant biomass—Biopak users guide. USDA Forest Service General Technical Report PNW-GTR-340.
- Minore, D., and J. C. Zasada. 1990. *Acer macrophyllum* Pursh Bigleaf maple. Pages 33–40 in R. M. Burns and B. H. Honkala, editors. *Silvics of North America*. USDA Agriculture Handbook 654. Volume 2: Hardwoods. USDA, Washington, D.C., USA.
- Mitchell, S. J., T. Hailemariam, and Y. Kulis. 2001. Empirical modeling of cutblock edge windthrow risk on Vancouver Island, Canada, using stand level information. *Forest Ecology and Management* **154**:117–130.
- Mohler, C. L., P. L. Marks, and D. G. Sprugel. 1978. Stand structure and allometry of trees during self-thinning of pure stands. *Journal of Ecology* **66**:599–614.
- Munger, T. T. 1946. Watching a Douglas-fir forest for thirty-five years. *Journal of Forestry* **44**:705–708.
- Oakley, B., and J. F. Franklin. 1998. Bitter cherry (*Prunus emarginata*) distribution, successional dynamics, and implications for the role of the seed bank. *Canadian Journal of Botany* **76**:1725–1732.
- Oliver, C. D. 1981. Forest development in North America following major disturbances. *Forest Ecology and Management* **3**:153–168.
- Oliver, C. D., and B. C. Larson. 1996. *Forest stand dynamics*. John Wiley and Sons, New York, New York, USA.
- Peet, R. K. 1981. Changes in biomass and production during secondary forest succession. Pages 324–338 in D. C. West, H. H. Shugart, and D. B. Botkin, editors. *Forest succession*. Springer-Verlag, New York, New York, USA.
- Peet, R. K., and N. L. Christensen. 1987. Competition and tree death. *BioScience* **37**:586–595.
- Pincheira, M. E. 2004. Changes in population structure, mortality and biomass of trees in old-growth Sitka spruce/western hemlock stands on the Olympic Peninsula of Washington. Thesis. University of Washington, Seattle, Washington, USA.
- Piri, T. 2003. Early development of root rot in young Norway spruce planted on sites infected by *Heterobasidium* in southern Finland. *Canadian Journal of Forest Research* **33**:604–611.
- Pittman, S. D., and E. C. Turnblom. 2003. A study of self-thinning using coupled allometric equations: implications for

- coastal Douglas-fir stand dynamics. *Canadian Journal of Forest Research* **33**:1661–1669.
- Platt, W. J., R. F. Doren, and T. Armentano. 2000. Effects of Hurricane Andrew on stands of slash pine (*Pinus elliottii* var *densa*) in the Everglades region of south Florida (USA). *Plant Ecology* **146**:43–60.
- Poage, N. J., and J. C. Tappeiner, II. 2002. Long-term patterns of diameter and basal area growth of old-growth Douglas-fir trees in western Oregon. *Canadian Journal of Forest Research* **32**:1232–1243.
- Rebertus, A. J., T. Kitzberger, T. T. Veblen, and L. M. Roovers. 1997. Blowdown history and landscape patterns in the Andes of Tierra del Fuego, Argentina. *Ecology* **78**:678–692.
- Rizzo, D. M., G. W. Slaughter, and J. R. Parmeter, Jr. 2000. Enlargement of canopy gaps associated with a fungal pathogen in Yosemite Valley, California. *Canadian Journal of Forest Research* **30**:1501–1510.
- Rothacher, J., C. T. Dyrness, and R. L. Fredriksen. 1967. Hydrologic and related characteristics of three small watersheds in the Oregon Cascades. USDA Forest Service Pacific Northwest Forest and Range Experimental Station, Portland, Oregon, USA.
- Ruel, J. C., D. Pin, and K. Cooper. 1998. Effect of topography on wind behaviour in complex terrain. *Forestry* **71**:261–265.
- Runkle, J. R. 1981. Gap regeneration in some old-growth forests of the eastern United States. *Ecology* **62**:1041–1051.
- Runkle, J. R. 2000. Canopy tree turnover in old-growth mesic forests of eastern North America. *Ecology* **81**:554–567.
- Ryall, K. L., and S. M. Smith. 2005. Patterns of damage and mortality in red pine plantations following a major ice storm. *Canadian Journal of Forest Research* **35**:487–493.
- Salogga, D. S. 1982. Occurrence, symptoms and probable cause, *Discula* species, of *Cornus* leaf anthracnose. Thesis. University of Washington, Seattle, Washington, USA.
- Savill, P. S. 1998. Silviculture in windy climates. *Forestry Abstracts* **44**:473–488.
- Sheil, D., D. F. R. P. Burslem, and D. Alder. 1995. The interpretation and misinterpretation of mortality rate measures. *Journal of Ecology* **83**:331–333.
- Shugart, H. H., D. C. West, and W. R. Emanuel. 1981. Patterns and dynamics of forests: an application of simulation models. Pages 74–94 in D. C. West, H. H. Shugart, and D. B. Botkin, editors. *Forest succession*. Springer-Verlag, New York, New York, USA.
- Sinton, D. S., J. A. Jones, J. L. Ohmann, and F. J. Swanson. 2000. Windthrow disturbance, forest composition, and structure in the Bull Run basin, Oregon. *Ecology* **81**:2539–2556.
- Smith, J. W. 2002. Mapping the thermal climate of the H. J. Andrews Experimental Forest, Oregon. Thesis. Oregon State University, Corvallis, Oregon, USA.
- Spies, T. A., and J. F. Franklin. 1989. Gap characteristics and vegetation response in coniferous forests of the Pacific Northwest. *Ecology* **70**:543–545.
- Spies, T. A., and J. F. Franklin. 1991. The structure of natural young, mature, and old-growth Douglas-fir forests in Oregon and Washington. Pages 90–109 in L. F. Ruggieri, K. B. Aubry, A. B. Carey, and M. H. Huff, technical coordinators. *Wildlife and vegetation of unmanaged Douglas-fir forests*. USDA Forest Service General Technical Report PNW-GTR-285.
- Spies, T. A., and J. F. Franklin. 1996. The diversity and maintenance of old-growth forests. Pages 296–314 in R. C. Szaro and D. W. Johnson, editors. *Biodiversity in managed landscapes: theory and practice*. Oxford University Press, New York, New York, USA.
- Spies, T. A., J. F. Franklin, and M. Klopsch. 1990. Canopy gaps in Douglas-fir forests of the Cascade Mountains. *Canadian Journal of Forest Research* **20**:649–658.
- Sprugel, D. G. 1976. Dynamic structure of wave-regenerated *Abies balsamea* forests in the north-eastern United States. *Journal of Ecology* **64**:889–911.
- Stewart, G. H. 1986. Population dynamics of a montane conifer forest, western Cascade Range, Oregon, USA. *Ecology* **67**:534–544.
- Tappeiner, J. C., II, D. Huffman, D. Marshall, T. A. Spies, and J. D. Bailey. 1997. Density, ages, and growth rates in old-growth and young-growth forests in coastal Oregon. *Canadian Journal of Forest Research* **27**:638–648.
- Taylor, A. H., and C. B. Halpern. 1991. The structure and dynamics of *Abies magnifica* forests in the southern Cascade Range, USA. *Journal of Vegetation Science* **2**:189–200.
- Turner, M. G., V. H. Dale, and E. H. Everham, III. 1997. Fires, hurricanes, and volcanoes: comparing large disturbances. *BioScience* **47**:758–768.
- van Mantgem, P. J., N. L. Stephenson, M. Keifer, and J. Keeley. 2004. Effects of an introduced pathogen and fire exclusion on the demography of sugar pine. *Ecological Applications* **14**:1590–1602.
- Van Pelt, R., and J. F. Franklin. 2000. Influence of canopy structure on the understory environment in tall, old-growth, conifer forests. *Canadian Journal of Forest Research* **30**:1231–1245.
- Veblen, T. T. 1989. Tree regeneration responses to gaps along a transandean gradient. *Ecology* **70**:541–543.
- Veblen, T. T., K. S. Hadley, E. M. Nel, T. Kitzberger, M. Reid, and R. Villalba. 1994. Disturbance regime and disturbance interactions in a Rocky Mountain subalpine forest. *Journal of Ecology* **82**:125–135.
- Weisberg, P. J. 2004. Importance of non-stand-replacing fire for development of forest structure in the Pacific Northwest, USA. *Forest Science* **50**:245–258.
- Wilson, B. F., and R. R. Archer. 1979. Tree design: some biological solutions to mechanical problems. *BioScience* **29**:293–298.
- Wilson, J. S., and C. D. Oliver. 2000. Stability and density management in Douglas-fir plantations. *Canadian Journal of Forest Research* **30**:910–920.
- Winter, L. E., L. B. Brubaker, J. F. Franklin, E. A. Miller, and D. Q. DeWitt. 2002a. Canopy disturbance over the five-century lifetime of an old-growth Douglas-fir stand in the Pacific Northwest. *Canadian Journal of Forest Research* **32**:1057–1070.
- Winter, L. E., L. B. Brubaker, J. F. Franklin, E. A. Miller, and D. Q. DeWitt. 2002b. Initiation of an old-growth Douglas-fir stand in the Pacific Northwest: a reconstruction from tree ring records. *Canadian Journal of Forest Research* **32**:1039–1056.
- Wright, S. J., H. C. Muller-Landau, R. Condit, and S. P. Hubbell. 2003. Gap-dependent recruitment, realized vital rates, and size distributions of tropical trees. *Ecology* **84**:3174–3185.
- Yoda, K., T. Kira, H. Ogawa, and K. Hozumi. 1963. Self-thinning in overcrowded pure stands under cultivated and natural conditions (intraspecific competition among higher plants). *Journal of Biology Osaka City University* **14**:107–129.
- Young, T. P., and S. P. Hubbell. 1991. Crown asymmetry, treefalls, and repeat disturbance of broad-leaved forest gaps. *Ecology* **72**:1464–1471.
- Zenner, E. K. 2005. Development of tree size distributions in Douglas-fir forests under differing disturbance regimes. *Ecological Applications* **15**:701–714.

APPENDIX

A figure showing relative abundance (proportion of total) of *Pseudotsuga*, hardwoods, and shade-tolerant conifers among plots in both watersheds at the first (1979/1980) and last (2001) measurements (*Ecological Archives* M076-010-A1).